

## WORK PACKAGE 2

# Hydrogen Purity

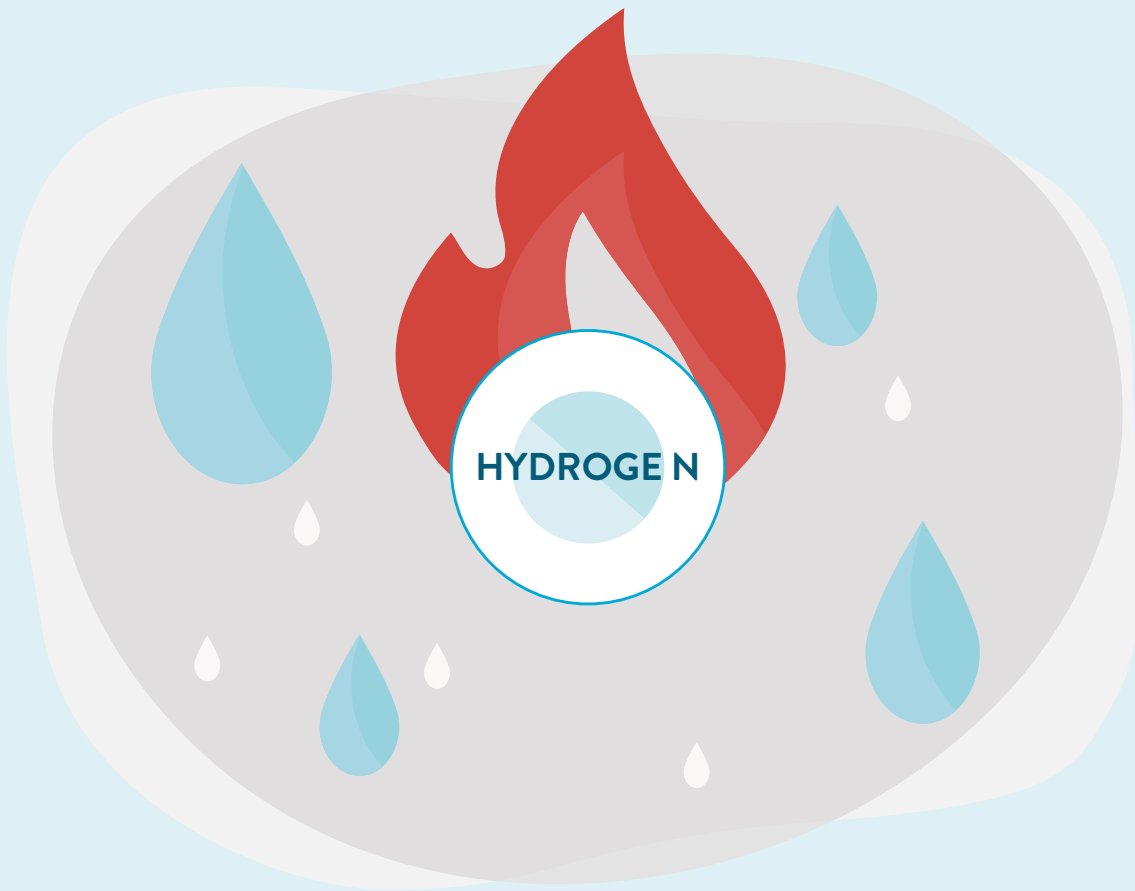

DNV·GL



elementenergy



HY4HEAT (WP2) HYDROGEN PURITY & COLOURANT

# Hydrogen Purity – Final Report

Department for Business, Energy & Industrial Strategy

**Report No.:** 10123173-FINAL PURITY, Rev. 05

**Date:** 2019-10-31



---

---

Project name: Hy4Heat (WP2) Hydrogen Purity & Colourant GL Industrial Services UK Ltd  
Report title: Hydrogen Purity – Final Report Holywell Park  
Customer: Department for Business, Energy & Industrial Ashby Road  
Strategy Loughborough  
1 Victoria Street, LE11 3GR  
London SW1H 0ET,  
United Kingdom  
Customer contact: Steve Loades  
Date of issue: 2019-10-31  
Project No.: 10123173  
Report No.: 10123173-FINAL PURITY, Rev. 05

---

### Objective:

To evaluate the varying hydrogen purity levels available in the UK and the potential impacts and cost effectiveness of introducing hydrogen at these quality levels into the wider distribution network and to recommend a purity level for use by the Hy4Heat programme. This will include developing and classifying information on any potential trace contaminants that might be picked up by the hydrogen as it is distributed through the pipeline network to end users.

---

Prepared by:



Martin Brown  
DNV GL

Verified by:



Colin Heap  
DNV GL

Approved by:



Michael Pritchard  
DNV GL



Arul Murugan  
NPL

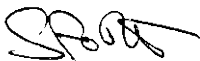

Sam Foster  
Element Energy

---

Copyright © DNV GL 2019. All rights reserved. Unless otherwise agreed in writing: (i) This publication or parts thereof may not be copied, reproduced or transmitted in any form, or by any means, whether digitally or otherwise; (ii) The content of this publication shall be kept confidential by the customer; (iii) No third party may rely on its contents; and (iv) DNV GL undertakes no duty of care toward any third party. Reference to part of this publication which may lead to misinterpretation is prohibited. DNV GL and the Horizon Graphic are trademarks of DNV GL AS.

---

DNV GL Distribution:

**OPEN. Unrestricted distribution, internal and external.**

INTERNAL use only. Internal DNV GL document.

CONFIDENTIAL. Distribution within DNV GL according to applicable contract.\*

SECRET. Authorized access only.

\*Specify distribution:

---

Rev. No.	Date	Reason for Issue	Prepared by	Verified by	Approved by
1	2019-06-03	Hydrogen Purity – Final Report	Martin Brown Arul Murugan Sam Foster	Colin Heap	Michael Pritchard
2	2019-07-19	Hydrogen Purity – Final Report	Martin Brown Arul Murugan Sam foster	Colin Heap	Michael Pritchard
3	2019-10-18	Hydrogen Purity – Final Report	Martin Brown Arul Murugan Sam foster	Colin Heap	Michael Pritchard
4	2019-10-25	Hydrogen Purity – Final Report	Martin Brown Arul Murugan Sam foster	Colin Heap	Michael Pritchard
5	2019-12-11	Hydrogen Purity – Final Report	Martin Brown Arul Murugan Sam foster	Colin Heap	Michael Pritchard



## Table of contents

1	EXECUTIVE SUMMARY .....	4
1.1	Summary	4
1.2	Project Objectives	4
1.3	Scope of Work	4
1.4	Methodology	5
1.5	Key Findings	6
1.6	Conclusions	9
1.7	Recommendations	10
2	INTRODUCTION .....	12
3	HYDROGEN PURITY LEVEL ASSESSMENT .....	13
3.1	Review of Documentary Standards for Hydrogen Quality Assurance	13
3.2	Implications of the Proposed Hydrogen Purity Standard	29
3.3	Production and Purification Methods	30
3.4	Data from the GDNO's	67
3.5	Assess Impurity Level at Point of Use	68
3.6	Output from the SGN Hydrogen 100 Project	69
3.7	Liaise with Cadent HG2V Project	71
3.8	Recommend optimum Purity Level	71
4	HYDROGEN PURITY LEVEL ASSESSMENT (OTHER OPTIONS).....	73
4.1	Quantify Purity Levels for Downstream Applications	73
4.2	Practical & Commercial Feasibility of Delivering Hydrogen	76
4.3	Available Clean up Technologies	78
4.4	Hydrogen Production Costs	78
4.5	Costs downstream of production	109
4.6	Cost Benefit Analysis	121
5	CONCLUSIONS .....	129
	APPENDIX A: GAS QUALITY SPECIFICATIONS.....	130
	APPENDIX B: DEMONSTRATION OF HYDROGEN PRODUCTION FROM FOSSIL FUEL PLANTS WITH CCUS .....	138
	APPENDIX C: UK PRODUCTION SITES .....	139
	APPENDIX D: HYDROGEN SAMPLING DATA .....	141
	APPENDIX E: LIST OF ABBREVIATIONS .....	143
	APPENDIX F: REFERENCES .....	144
	APPENDIX G: LIST OF TABLES.....	149
	APPENDIX H: LIST OF FIGURES .....	151

# 1 EXECUTIVE SUMMARY

## 1.1 Summary

Hydrogen is considered to be one potential option to support the UK government's approach to the decarbonisation of energy use. As domestic and commercial heat provision is a significant contributor to the overall carbon dioxide emissions, it is timely to evaluate the options for this sector.

To support the overall aims of the Hy4Heat programme to evaluate the technical viability of distributing hydrogen to decarbonise heat supply for domestic and commercial users, an in depth understanding of the system implications for using hydrogen gas is required.

The Hy4Heat programme is divided into several Work Packages and the requirement of this Work Package 2 is to develop and document evidence on hydrogen purity that will support the subsequent Work Packages such as domestic and commercial appliance development.

The hydrogen Purity Specification and recommendations as set out in this report will be used in any unoccupied trials (Hy4Heat Work Package 8) and potentially in future occupied trials which are being explored in Work Package 9.

This report makes up only part of the Hy4Heat Work Package 2, with hydrogen colourant and hydrogen standards also contracted out under this work package and reported separately.

## 1.2 Project Objectives

To evaluate the range of hydrogen production sources and purity levels available in the UK, and the potential impacts and cost effectiveness of introducing hydrogen at these quality levels into the wider distribution network and to recommend a purity level for use by the Hy4Heat programme as part of an unoccupied trial (Hy4Heat Work Package 8) and potential future occupied trialling (Hy4Heat Work Package 9). This will include developing and classifying information on any potential trace contaminants that might be picked up by the hydrogen as it is distributed through the pipeline network to end users.

## 1.3 Scope of Work

### 1.3.1 To gain a detailed understanding of hydrogen purity levels

- Review national and international hydrogen standards and report on hydrogen purity options to be used in the IGEM gas quality standard
- Report on the different hydrogen purity levels produced in the UK including production methods available and the type and quantity of impurities found
- Obtain data from gas distribution networks on impurities picked up by methane and likely to impact hydrogen
- Assess the expected impurity level at the point of use from potential contributors (odorant, colourant and pipework contaminants) and an assessment of the potential economic impacts that might result.
- Consider outputs and findings from other relevant work to ensure findings are aligned for the purity level recommended
- Recommend the optimum purity level of hydrogen to be delivered by a repurposed GB gas network to domestic and commercial users

### 1.3.2 To identify applications and collate information on the purity levels required by different technologies

- Collate information on hydrogen purity levels required by different technologies
- Report on the practical and commercial feasibility of delivering hydrogen, which at the point of use, is suitably pure for use without the need for on-site clean-up
- Examine at a high level, the costs associated with producing hydrogen to varying levels of purity and comparing these to the costs of delivering hydrogen of a lower purity level downstream (such as the cost of clean-up technologies, and the cost of the impacts on end-user appliances).
- Report on gas clean up technologies and practical and commercial feasibility of hydrogen purification to meet requirements at the point of end use

## 1.4 Methodology

### 1.4.1 Literature Review

We gathered background information from published literature sources and using industry contacts from the project partners to review existing hydrogen quality standards.

We reported on the quality requirements from all hydrogen standards and applications, which we have used as a starting point for the new hydrogen purity specification.

We sourced literature data on the required hydrogen purity level for a wide range of downstream applications; including hydrogen flame combustion, fuel cells (PEMFC and SOFC), catalytic combustion and combined heat and power generation.

### 1.4.2 Key Stakeholder Consultation

Our partners contacted key stakeholders within the UK hydrogen industry to define the required features and factors of a hydrogen purity specification.

Through consultation with IGEM and BEIS and by additional feedback from key stakeholders, we obtained their views on existing hydrogen quality standards, identified information on technical aspects omitted from current hydrogen standards and considered new applications where hydrogen quality standards did not exist.

Through involvement in several on-going or recently completed Network Innovation projects that involved either pure hydrogen or hydrogen/natural gas blends, we determined the options for and costs of producing hydrogen to different varying purity standards for a future GB hydrogen network.

### 1.4.3 Impurities / Contaminants

We identified possible impurities in hydrogen from the different production processes. This was incorporated into the literature review and discussed with stakeholders.

We studied the probability of the presence of contaminants in hydrogen from currently available production and purification methods (steam methane reformation, autothermal reformation purified by pressure swing adsorption and PEM water electrolysis and chlor-alkali membrane electrolysis both purified with temperature swing adsorption).

We contacted gas quality experts in the GB distribution companies to collate information on the range and concentration of possible contaminants from existing pipeline network knowledge. From this, we estimated the range and concentration of a number of potential contaminants.

## 1.4.4 Hydrogen Purity Requirements

Based on the findings from the literature review, stakeholder consultation and results provided by other hydrogen projects (such as HG2V, SGN H100), we proposed a Hydrogen Purity Specification for domestic and commercial heating applications (boilers, cookers and fires) in the UK.

The Hydrogen Purity Specification was presented to key stakeholders in a dedicated workshop to obtain their feedback, comments and most importantly so they could raise issues with any of the findings and recommendations as set out in the report.

## 1.4.5 Cost Analysis

We evaluated the practicality and high-level costs associated with the delivery of hydrogen purity to meet domestic and commercial end-user needs.

We considered potential hydrogen purity levels delivered and examined the costs of producing a higher purity at point of production for several production methods. Where applicable we compared these to the costs of on-site clean-up.

We conducted a sensitivity analysis to different appliance stock compositions, as this may alter the extent to which it is cost-effective to deliver hydrogen at a purity that requires on-site clean-up for certain technologies, versus achieving a higher purity at the point of production.

We included data on the sensitivity of appliance lifetime and operating costs to hydrogen purity in the analysis of the trade-off between gas clean-up costs and appliance costs. This was supported by a detailed review of the literature on cost-benefit analyses of different approaches to achieving differing hydrogen purity standards.

## 1.5 Key Findings

### 1.5.1 A new Hydrogen Purity Specification was required for domestic / commercial heating applications

The literature review undertaken for this project found several useful information sources or guidance on quality recommendations for hydrogen used for heating, but most of the documents reviewed were specifically for natural gas, biomethane or hydrogen for PEM fuel cell applications.

- The key, existing documentary standard that provides recommended hydrogen quality for heat applications is ISO/FDIS 14687 which includes a Grade A specification for appliances such as hydrogen boilers and cookers.
- However, for this study, this document was considered “not fit for purpose” as it may have been originally based on PEM fuel cell applications and may not have considered all options for traditional combustion appliances. Also, it does not include input from appliance manufacturers.
- A new Hydrogen Purity Specification for use in domestic and commercial heating applications was therefore needed.

### 1.5.2 The development of the new Hydrogen Purity Specification gathered input from several key stakeholders

Discussions with gas quality experts within the Gas Distribution Network Operators (GDNO’s) revealed the following:

- Distribution of hydrogen through a pipeline network is not conducive with ultra-high purity requirements and that it is inevitable for the purity to be impacted.



- With regards to safety, the general public is familiar with the current odorant used for natural gas, so it is possible that the same odorant may be used for hydrogen. Initial tests of odorant in hydrogen suggest that a similar addition rate will be required and will be appropriate from a gas leakage detection viewpoint.
- Oxygen content has to be limited. The upper concentration limit for oxygen in natural gas is in place to reduce corrosion rates and maintain pipeline integrity. As it is assumed that the existing pipelines will be repurposed for hydrogen use, a limit similar to the current GS(M)R value would be appropriate.
- Some large-scale hydrogen production methods would introduce minor components, like carbon dioxide, carbon monoxide, methane and water. From a safety perspective for all stakeholders, a carbon monoxide concentration limit should be considered as mandatory. This study suggests that a carbon monoxide concentration limit in line with the short-term exposure limit as set out in HSE EH/40 is appropriate as an upper limit.
- Water content should be both minimised and managed to ensure that it remains in the gas phase and will not drop-out to form a liquid. Water will impact on gas flow, affect network operations and could accelerate the corrosion process.
- It is proposed that water content is managed through water dewpoint measurements in the same manner as for natural gas, as this is an approach adopted by pipeline network operators.

From appliance manufacturers, fuel cell manufacturers and GDNO's, point of use impurity levels were assessed, with the following recommendations:

- The fuel gas should be non-toxic and not produce hazardous combustion products
- The impurities should not impact on the utilisation process i.e. they should not impact on flame stability or the fundamental combustion processes
- The impurities should not impair any gas or flame detection systems
- For boilers, the impurities should not influence the acidity or viscosity of the condensate nor affect the integrity or operation of the heat exchangers

Outputs from the SGN H100 project with regard to odorant were considered:

- Five odorants were identified through a literature review. Olfactory testing indicated that four odorants were suitable for hydrogen in the gas grid
- The HSE confirmed that there were no issues with these odorants at the concentration levels they would be present in pipelines in the detection of a gas leak
- Testing is underway to investigate how these odorants affect boiler degradation, pipelines (stainless steel and polyethylene) and fuel cells as found in hydrogen fuel cell vehicles.
- A recommendation on a suitable odorant for the unoccupied trial (Hy4Heat WP8) and preparation for future trialling (Hy4Heat WP9) will be made, together with a longer-term view on odorant options for future wide-scale deployment of hydrogen
- The SGN H100 project will evaluate the odorant concentration required - The early indication is that the odorant concentration will be similar to that required for natural gas.
- The odorant concentration will impact on the total sulphur content and this is accommodated within the proposed purity specification (as detailed in Table 1 of this report).

Outputs from the Cadent Hydrogen Grid to Vehicles (HG2V) project which evaluated the feasibility to use the existing natural gas network for hydrogen fuel cell vehicles were considered:

- A HG2V workshop supported and endorsed the Hy4Heat purity themes as set out in this report
- The key impurities may be carbon monoxide and sulphur-containing molecules, depending on the hydrogen production method.
- Odorant and colourant requirements were also discussed, and an overview of the information has been included in this report.

### 1.5.3A new Hydrogen Purity Specification has been created

A new draft hydrogen Purity Specification which is suitable for the majority of domestic end-use applications is given in this report (see Table 1). **This new Hydrogen Purity specification recommends a minimum purity standard** (i.e. the purity of the delivered hydrogen content should lie between 98 and 100%, and the value detailed in the specification documentation), based on considerations from existing quality recommendations for natural gas, possible new impurities from hydrogen production processes and feedback from stakeholders and built around published technical evidence where possible.

The hydrogen purity specification recognises that delivery of hydrogen through an established pipeline network may result in pick-up of existing trace contamination, and a pragmatic approach on component limits within the specification accounts for this.

The implications / limitations of this new Hydrogen Purity Specification are set out as follows:

- Hydrogen produced by electrolysis and then dried with temperature swing adsorption (TSA) will meet this standard
- Hydrogen produced by an ATR or SMR with carbon capture (CC) and no further purification would not meet this standard – due to high CO and higher methane, carbon dioxide and total hydrocarbon content. However, with purification using pressure swing adsorption, which is currently industry standard practice, this standard can be met

### 1.5.4 Costs associated with varying purity levels were investigated for methane reformer and electrolysis-produced hydrogen.

Methanation and pressure swing adsorption (PSA) are the two currently available technologies that could be used to reduce carbon monoxide from hydrogen produced by reformation to safe levels. When used to reduce carbon monoxide levels to those considered here, PSA also reduces other impurities to levels with low impact on the end users considered. Methanation, however only reduces the carbon monoxide and carbon dioxide levels.

Additional hydrogen production costs to reduce carbon monoxide using these technologies, in the case of reformer-based production, were considered, with the following key findings:

- PSA is capable of reducing the level of carbon monoxide to 1 ppm or less. When ATR and SMR reformers were examined, the additional levelized cost of energy (LCOE) of purifying carbon monoxide from 250 ppm to 1 ppm using PSA ranged from 0.01 to 0.05 p/kwh.
- Methanation can be used to meet a carbon monoxide limit down to 10 ppm, but not a 1 ppm limit. However, for some reformers, we find methanation can be lower in cost than using PSA to achieve the purity limits between 10 ppm and 250 ppm carbon monoxide. Considering methanation as a more cost effective option to meet the 250 ppm limit therefore leads to an increase in the additional LCOE of achieving the 1 ppm limit (where PSA must be used) compared with the 250 ppm limit

(where either methanation or PSA can be used) for some reformers. Considering methanation leads to an increased range of additional costs of producing hydrogen with 1 ppm carbon monoxide compared to 250 ppm carbon monoxide of 0.01 to 0.39 p/kWh.

- The additional LCOE associated with using the 'lowest CO<sub>2</sub> emission' ATR reformer with carbon capture to supply hydrogen with 1 ppm CO in place of using the same reformer to produce hydrogen with 250 ppm CO were between 0.01 p/kWh and 0.02 p/kWh per year. For this specific ATR, methanation does not offer a lower cost purification option for any purity and the cost impact of PSA is small, leading to the small cost increase associated with using a PSA to purify to 1 ppm in place of 250 ppm. The additional costs to produce to the fuel cell standard (0.2 ppm CO) with this ATR + PSA instead of 1 ppm are a further 0.002 p/kWh to 0.005 p/kWh.

Electrolysis produced hydrogen with drying meets the highest purity considered in this analysis and there is no additional cost from increasing the carbon monoxide purity to 0.2 ppm (that required by fuel cell vehicles).

### 1.5.5 Downstream costs were considered, particularly with regard to the impact on the end user

- A stakeholder engagement exercise found that the draft standard would not have any significant impact on the costs of using hydrogen in boilers and cookers
- The impact of impurities on PEM fuel cells were deemed to be more significant than other applications considered
- Fuel cell use to calculate end user impact was not modelled – it was assumed that downstream clean-up would be required where a given purity impacts an end user.
- The costs of transporting 2% inert gases were estimated to range from 0.02 – 0.03 p/kWh
- Indicative sampling and verifying costs were examined to determine whether these will require further analysis

### 1.5.6 A cost benefit analysis found that:

- The cost impact of impurities present at the levels considered in this report is only anticipated to be significant for PEM and solid oxide fuel cells
- The hydrogen production process and options for clean-up have undergone a cost benefit study using selected target scenarios. For some scenarios (i.e. a scenario with higher hydrogen transport demand and lower heat / combustion hydrogen demand), the ratio of hydrogen PEM fuel cell demand to hydrogen combustion demand may make it more cost-effective for the grid to deliver hydrogen at the ISO/DIS 14687 standard for vehicle PEM fuel cells, rather than at the lower purity level as detailed in Table 1 of this report.
- However, there are many cases shown where this does not hold, and the overall system cost is lower when hydrogen is delivered at a lower purity level.
- The two largest uncertainties were the costs of purification at the point of use for PEM fuel cell applications, and the future demands for hydrogen from the grid used in PEM fuel cell and combustion applications.

## 1.6 Conclusions

- The Hydrogen Purity Specification has been created following a thorough review of existing standards, recognising that there is not a current specification available for hydrogen purity requirements for



traditional domestic appliances such as boilers, cookers and fires. The Hydrogen Purity Specification recognises the purity limits of different production methods and considers the impact of the different trace components that might be present. It also includes consideration of the pick-up of existing trace contamination from reuse of an existing natural gas pipeline system. The purity specification is a pragmatic view on an achievable hydrogen quality that can be delivered to domestic end-users.

- The Hydrogen Purity Specification has been shared with a broad range of stakeholders including producers, network operators, equipment designers, appliance manufacturers and technical consultants and responses collated. For some scenarios (those with higher hydrogen transport demand and lower heat/combustion hydrogen demand) it may be more cost-effective for the national grid to deliver hydrogen at ISO/DIS 14687 standard for vehicle PEMFC, rather than at a lower purity level.
- Until there is greater certainty on the potential replacement of natural gas with hydrogen, it will be difficult to address the costs of purification at the point of use for PEM fuel cell applications, and the future demand for hydrogen from the grid used in PEM fuel cell applications and combustion applications. Also uncertain are the potential incentives to commercialise point of use purification technologies and a clearer picture of the likely PEM fuel cell and combustion demand for hydrogen in the grid.
- Given these uncertainties, no firm conclusions can be drawn at this stage on the most cost-effective level of purity for hydrogen delivered through the grid. The cost-benefit analysis undertaken does however provide an insight into the circumstances in which different levels of purity of hydrogen in the grid may lead to the most cost-effective outcome and highlights the factors that could influence the optimal purity specification.

## 1.7 Recommendations

- The Hydrogen Purity Specification has been shared with stakeholders and other teams within the Hy4Heat programme and should be more widely distributed. It is suggested that this forms the basis of discussions with ISO and CEN for a wider adoption of the approach and limits. It is recognised that this will involve additional challenges on the trace component levels and the purity specification may need to be modified in light of these discussions.
- The Hydrogen Grid to Vehicles (HG2V) project will produce information on additional trace components that may be present, and the Hy4Heat programme will endeavour to review information from this project to further enhance the justification for specific trace component concentration limits.
- It is suggested that the dissemination of this Hydrogen Purity Specification (for use in the Hy4Heat trial), to the wider hydrogen industry will provide a target to inform their future production designs and to encourage the development of downstream clean-up technologies.
- As it is clear that additional clean-up technologies may be required, it is proposed that additional programmes are developed to support technology improvement trials of novel, point of use, clean-up technologies for fuel cell applications. The lack of demonstration of these technologies leads to their cost being the most uncertain element of the cost benefit analysis. These costs need to be better understood to inform a decision on the wider gas network hydrogen purity standard.
- It is proposed that an updated cost benefit analysis of a purity standard to be used for hydrogen transported through the wider gas network is undertaken once the clean-up technologies have been developed. This updated analysis would factor in developments of point of use clean-up technologies,



hydrogen production and demand for hydrogen used in fuel cells for transport or stationary applications.

## 2 INTRODUCTION

Hydrogen is considered as one potential option to support the UK governments approach to decarbonisation of energy use. As domestic heat provision is a significant contributor to the overall carbon dioxide emission, it is timely to evaluate the options for this sector.

The Hy4Heat programme is extending the current knowledge base to understand the practicality and costs for utilisation of hydrogen for domestic applications focusing on space heating (central heating and fires) and cooking. The programme is divided into several sub-parts and the requirement of Work Package 2 is to develop and document evidence on hydrogen purity and colourant that will enable the subsequent Work Packages to use this to assist with domestic appliance development.

Hy4Heat Work Package 2 (WP2) is collating information on hydrogen production, purification and end-use requirements to ensure the safe and reliable utilisation. WP2 considers hydrogen purity requirements for the end users, the impacts of network distribution with regard to trace contaminants and flame visualisation.

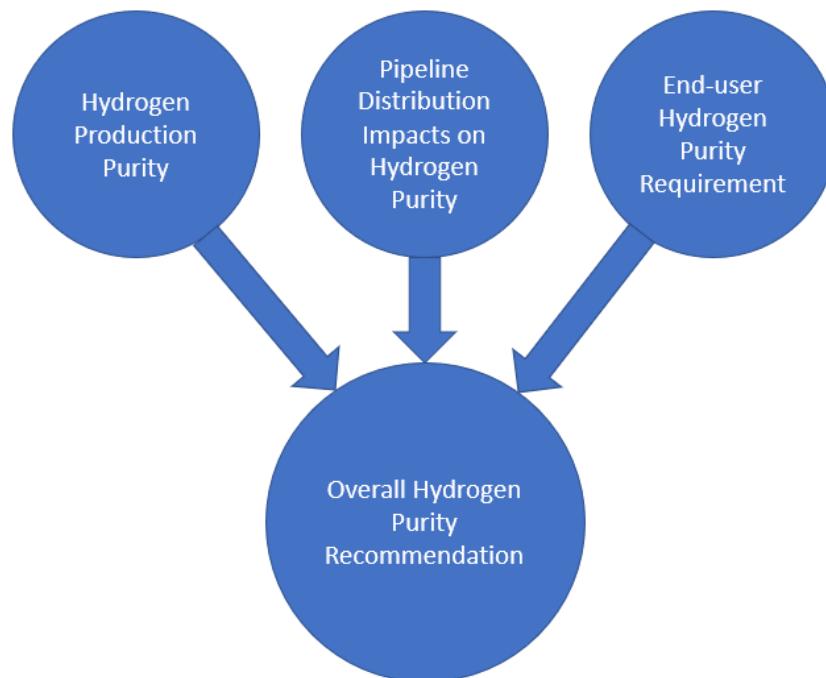

**Figure 1: Factors influencing hydrogen purity and the development of a recommended specification**

## 3 HYDROGEN PURITY LEVEL ASSESSMENT

To develop a detailed understanding of the hydrogen purity levels that are suitable for the proposed hydrogen trial (WP9 of the Hy4Heat programme) and potentially a future GB hydrogen network, a range of tasks have been set-out to gather information on the purity of hydrogen. The information includes data from a number of production sources, collation of purity information from currently available standards, identification of views from stakeholders on the purity requirements for other activities within the overall Hy4Heat programme and includes supporting information from other hydrogen projects. The outcomes of this work are set out in the following report sub-sections.

### 3.1 Review of Documentary Standards for Hydrogen Quality Assurance

#### 3.1.1 Introduction

Hy4Heat WP2 focuses on developing a recommendation on quality specifications for hydrogen in the grid. This is primarily for heat applications such as hydrogen powered boilers and cookers but supply of hydrogen to refuelling stations for transport will also be considered (which is relevant for other UK projects such as the Cadent Gas Hydrogen Grid to Vehicles project).

This section of the report reviews existing documentary standards on hydrogen quality from global standardisation committees, and other relevant technical reports and recommendations. Additionally, relevant stakeholders have been contacted to understand their views on these existing standards and whether they are fit-for-purpose should the UK implement them into our current regulations. It is important to ensure that UK industry is properly consulted before establishing a recommended standard for hydrogen gas quality

#### 3.1.2 Committees & Associations

##### **International Organisation for Standardisation (ISO)**

The International Organisation for Standardisation develops propriety, industrial and commercial standards that are utilised or adopted by countries worldwide; commonly known as ISO standards. It is a voluntary organisation in which representatives from each country (such as BSI for the UK) can develop and vote on international standards. In most cases these standards provide guidance and recommendations, but can become regulatory if referenced by, for example, a European Directive and national legislation.

For hydrogen quality, ISO TC 197 Hydrogen Technologies provides guidance and has developed several relevant International Standards. It is not yet clear which technical committee would provide standards specifically for a 100% hydrogen grid. ISO TC 193 Natural gas has recently included biogas, biomethane and shale gas within its scope. ISO TC 158 Gas analysis includes gas analysis methods, sampling and preparation of gas mixtures.

##### **European committee for standardisation (CEN)**

The European Committee for Standardisation develops European (EN) Standards. EN standards can be developed specifically for Europe without approval or influence from ISO (and therefore other global nations). It is, however, also possible to directly adopt ISO standards as EN standards – this relates to the Vienna Agreement signed between CEN and ISO in 1991 to ensure that similar standards between the two organisations are harmonised. The relevant working group for hydrogen quality is CEN TC 268 WG5 Specific hydrogen technologies applications. Delegates join the working group or committees as delegates of their national standardisation body (such as BSI for the UK). CEN TC 234 Gas infrastructure may also be relevant as its scope includes gas quality and injection of non-conventional gases.

### **British Standards institute (BSI)**

The British Standards Institute host working groups that can mirror EN and ISO technical committees or operate independently. BSI can adopt standards directly from CEN or ISO. One of the roles of BSI committees is to provide UK representation at EN and ISO level to develop and vote on standards. Each country represented can only provide one vote. At BSI, the relevant working group for hydrogen quality is BSI PVE 3 8 Gas containers – Hydrogen technologies which mirrors ISO TC 197 and CEN TC 268. PVE 3 8 has a designated liaison to link with BSI PTI 15 (which mirrors ISO TC 158 gas analysis and ISO TC 193 Natural gas) and BSI PVE 18 Cryogenic vessels (which mirrors CEN TC 268).

### **Society of Automotive Engineers International (SAE)**

SAE International was initially established as the Society of Automotive Engineers. It is a US based organisation which provides its own technical standards to support the US transport industry. SAE does not provide representation at ISO as this role falls with the American National Standards Institute (ANSI) and the other national standardisation bodies that cover Canada, Mexico and countries within South America. Within the society is the Fuel Cell Standards Committee which have written a standard on hydrogen fuel quality for fuel cell vehicles.

### **Institution of Gas Engineers and Managers (IGEM)**

The Institution of Gas Engineers and Managers is a chartered professional body that provides guidance and develops technical standards to support the gas industry. Expertise provided may include legislation, quality, safety and metering. Although the institution is UK based, it is open to members from overseas. The IGEM Gas Quality working group had its first meeting in 2016 chaired by SGN; the focus of the working group is to develop a new technical standard that provides an up-to-date revision of the Gas Safety (Management) Regulations 1996 (GSMR1996), [1] which currently provides the UK's quality specification for natural gas. The updated standard may include components to allow injection of biomethane and hydrogen.

Current concerns with GSMR1996 is that it does not include a threshold limit for siloxanes (or total silicon), which can be present in biogas. According to DNV GL, siloxanes present in natural gas can form silica when combusted which can significantly reduce performance of home appliances. [2] Regarding hydrogen injection, GSMR1996 specifies an upper limit for hydrogen at 0.1% volume. To enable hydrogen enriched natural gas, this limit may need to be increased to around 20% volume.

### **European Association for the Streamlining of Energy Exchange – GAS (EASEE-gas)**

The European Association for the Streamlining of Energy Exchange – Gas was set up in 2002 to facilitate transfer and trading of gas between European countries. Members include gas producers, transporters, distribution network operators, traders, suppliers and end-users. Within the association is a task force on hydrogen, biogas and energy transition (TFHBET).

### **European industrial gases association (EIGA)**

The European Industrial Gases Association hosted in Brussels comprises member companies that develop technical standards and as a consortium provide expert knowledge to standardisation committees (such as within CEN). There are over fifteen working groups which provide expertise on topics such as transport, safety, gas cylinders and specific industrial applications (including a working group on hydrogen energy). EIGA can influence changes in standardisation as a voice of the European gas industry.





### **British Compressed Gases Association (BCGA)**

The British Compressed Gases Association is the equivalent of EIGA at UK level and comprises members of the UK gas industry. The association's mission matches that of EIGA with the aim of providing expertise in transport, storage, use and handling of gases in various industries. Representatives of BCGA can sit on BSI committees such as BSI PVE 3 and PSI PVE 3 8 to provide technical expertise and voice the opinions of BCGA.

### **3.1.3 Documentary Standards & Reports**

A summary of the documents reviewed in this section is shown in Table 2.

Document number	Title	Year of publication	Author	Comments	Ref.
GSMR 1996	Gas safety (management) regulations 1996	1996	Health and safety executive	Technical specifications for natural gas quality in the UK	1
EIGA IGC Doc 15/06/E	Gaseous hydrogen stations	2006	EIGA	No specific purity requirements are specified although the use of gas purity analysers is mentioned	3
E10064-TB10.25	EASEE-gas – Gas quality specification	2010	EASEE-gas	This document provides a proposal for natural gas quality in Europe	4
EIGA IGC Doc 121/14	Hydrogen pipeline systems	2014	EIGA	Appendix I includes something on purity	5
EN 16726	Gas infrastructure - Quality of gas - Group H	2015	CEN TC 234	Provides quality of gas for Group H gas which has a Wobbe Index between 45.7 MJ m <sup>-3</sup> and 54.7 MJ m <sup>-3</sup>	6
SAE J2719	Hydrogen fuel quality for fuel cell vehicles	2015	SAE Fuel Cell Standards	US standard - hydrogen purity specifications for fuel cell vehicles (aligned with ISO 14687-2)	7
KIWA 20686	DECC Desk study on the development of a hydrogen-fired appliance supply chain	2016	KIWA / E4tech	Provides purity requirements for the Giacomini hydrogen boiler	8
H21 final	H21 final report	2016	H21	Information is provided on recommended purity for hydrogen in the grid	9
BCGA CP 41	The design, construction, Maintenance and operation of filling stations dispensing gaseous fuels	2016	BCGA	Recommendations are provided for fuel quality for hydrogen and natural gas at refuelling stations	10
EN 16723	Natural gas and biomethane for use in transport and biomethane for injection in the natural gas network - Automotive fuels specification	Part 1 – 2016 Part 2 - 2017	CEN TC 408	Guidance on quality requirements on biomethane for fuelling vehicles and injection to the grid (including additional impurities specific to biogas such as siloxanes)	11-12
EN 17124	Hydrogen fuel - Product specification and quality assurance - Proton exchange membrane (PEM) fuel cell applications for road vehicles	2018	CEN TC 268 WG5	Guidance on purity specifications and quality control for hydrogen refuelling stations	13
ISO 14687 (Previously ISO 14687-1, 2 & 3)	Hydrogen fuel quality - Product specification	(2019)	ISO TC 197 WG27	Hydrogen purity specifications for fuel cell vehicles, stationary fuel cells and non-PEM fuel cell applications such as hydrogen boilers and cookers	14

**Table 2: Summary of relevant documentary standards or technical reports that provide guidance on natural gas or hydrogen quality**

## **Gas Safety (Management) Regulations 1996**

In the UK, the Gas Safety (Management) Regulations 1996 (GSMR 1996) written by the Health and Safety Executive provides quality requirements for natural gas provided to consumers. The gas composition must meet the specifications shown in Appendix A, Table 47. This is a very important document for the UK as all gas distributors ensure they meet these specifications. Any deviation from these specifications must be agreed by HSE and an exemption granted.

The specifications were set based on natural gas, and do not consider biomethane or hydrogen enriched natural gas (where gas can be considered decarbonised by injecting up to 20% hydrogen). According to various reports there are plans to either alter the specifications in GSMR 1996 or move the specifications into an industry standard overseen by IGEM. Until then, HSE can grant gas distribution networks exemptions, which allows them to operate outside of a defined part of GSMR 1996.

The amount fraction equivalent of  $5 \text{ mg m}^{-3}$  at standard temperature and pressure (STP) is  $3.5 \text{ } \mu\text{mol mol}^{-1}$ . It is not possible to directly convert total sulphur as a mass concentration to molar fraction without knowing the level of different sulphur compounds contained but assuming total sulphur is only hydrogen sulphide (which would provide a conservative value), the amount fraction at STP would be  $35 \text{ } \mu\text{mol mol}^{-1}$

### **EIGA Gaseous Hydrogen stations [3]**

This document was written before any recommendations on hydrogen quality for fuel cell vehicles were established. The only mention of purity in the document is a recommendation to the use of "appropriate analytical instruments to ensure the correct operation of the purifications system."

### **EASEE-gas – Gas quality specification [4]**

This document details a proposal on gas quality provided by the European Association for the Streamlining of Energy Exchange, and its purpose was to facilitate transfer of natural gas between European nations. The proposed gas specification is shown in Appendix A, Table 48. SGN's 'Opening Up the Gas Market' project investigated whether natural gas that met EASEE-gas specifications but sat outside of GSMR1996 could be distributed safely in the UK. The results proved that this was the case and one the recommendations was therefore for HSE to change GSMR 1996 accordingly to match EASEE-gas.

A potential issue with the EASEE-gas specifications is the limitations on relative density which may prevent injection of hydrogen due its extremely low relative density. The amount fraction equivalent of  $5 \text{ mg m}^{-3}$  of hydrogen sulphide and carbonyl sulphide at STP is  $3.5 \text{ } \mu\text{mol mol}^{-1}$  and  $2 \text{ } \mu\text{mol mol}^{-1}$ , respectively. A maximum limit of  $30 \text{ mg m}^{-3}$  of total sulphur is equivalent to  $21 \text{ } \mu\text{mol mol}^{-1}$  (of hydrogen sulphide) at STP.

### **EIGA Hydrogen pipeline systems [5]**

This document was prepared by member associations within the International Harmonisation Council and includes members from Asia, America and Europe gas associations. One part the document provides recommended hydrogen purity for pipelines although the technology applications mentioned are semiconductors and electronics (opposed to fuel cell vehicles and home appliances). For these applications, a purity of 99.995% is specified where the specific impurities may be decided during contract. It is also noted that the allowable levels of impurities would depend on the end-use application.

### **EN 16726 – Gas infrastructure – quality of gas – group h [6]**

This standard was written by CEN TC 234 Gas Infrastructure and provides a general gas quality requirement to enable easy transfer of gas between European nations. It is specifically mentioned in the introduction that it was not possible to agree on a limit value for hydrogen that would acceptable for all parts of the European gas infrastructure. This could be due to the fact that natural gas in various parts of Europe may require



different hydrogen limits, and these requirements may differ for natural gas provided to vehicles, gas turbines, gas engines and when stored in underground porous rock storage. The water dew point in this standard is set at -8°C, and for hydrocarbon dew point the limit is -2°C (either at 70 bar or at the highest maximum operating pressure within the gas system). There is no rationale explaining why these limits were set in the standard, but it is presumably to avoid condensation.

### **SAE J2719 – Hydrogen Fuel Quality for fuel cell vehicles [7]**

This standard, written by SAE International, provides a quality specification for hydrogen provided to fuel cell vehicles. As shown in Appendix A, Table 49, the impurities and their amount fraction threshold levels match ISO 14687-2 (2012), and it is expected to be harmonised with ISO 14687 (2018) in due course. This standard provides no additional information that can contribute to this study.

### **DECC Desk study on the development of a hydrogen-fired appliance supply chain**

This report written by Kiwa and E4Tech provides results from the study they carried out to understand the technical challenges and costs of developing appliances that could operate on 100% hydrogen and includes some information on purity. The report does mention that at the time of writing, there appears to be a lack of information on hydrogen purity for appliances including threshold limits of carbon monoxide, sulphur and odorants. There is reference to the Italian manufacturer Giacomini who have developed a 5-kW hydrogen boiler (using catalytic burner) which required hydrogen purity of 99.5 %.

The report also mentions a Japanese study where cyclohexene was identified as a possible odorant for hydrogen gas, however the tests concluded that this compound had too much of a pleasant smell to be used as an odorant.

### **H21 final report [9]**

The Leeds City Gate H21 project investigates the feasibility of converting the natural gas network in Leeds to a 100% hydrogen gas grid. Within the report, the same Giacomini hydrogen boiler as mentioned above is referenced, with the same purity requirements of 99.5 % hydrogen. The report also specifies threshold impurity levels and proposes the specifications shown in Appendix A, Table 50.

As the rationale for setting the threshold limit for carbon monoxide at 15  $\mu\text{mol mol}^{-1}$  is based on PEM fuel cell applications, it should be considered whether this limit can be raised for combustion applications such as hydrogen boilers and cookers. The report discusses the issue of using sulphur-based odorants and its poisonous effects on PEM fuel cells, and cyclohexene is suggested as an alternative odorant. As reported [8] cyclohexene has a pleasant smell and so would not be practical as a replacement odorant for the gas grid.

### **BCGA – Code of practice 41 – The design, construction, maintenance and operation of filling stations dispensing gaseous fuels [10]**

The British Compressed Gas Association have written a code of practice for refuelling stations which includes liquefied natural gas (LNG), compressed natural gas (CNG) and hydrogen for both fuel cell and internal combustion engine vehicles. For hydrogen quality for fuel cell vehicles, the document refers to ISO 14687-2 (2012). Regarding hydrogen quality for internal combustion engines, no reference is provided, and it is stated that “quality specifications for non-PEM hydrogen are available from gas suppliers.” For LNG and CNG, the EN standards EN 16723 and EN 16726 are provided as recommendations for fuel quality.

### **EN 16723 - Natural gas and biomethane for use in transport and biomethane for injection in the natural gas network [11, 12]**

This European standard provides recommendations for gas quality when considering biomethane for injection into the natural gas grid (part 1) and for automotive applications (part 2). Although this standard is not



directly related to hydrogen, it may be of interest when considering hydrogen produced from biogas which is not currently covered under other documentary standards. One of the important issues with natural gas made from biogas is siloxanes, which if present in natural gas could produce silica when combusted and reduce performance of home appliances.<sup>2</sup> EN 16723-1 provides a maximum limit of 0.3 – 1 mgSi m<sup>-3</sup>.

The standard mentions that the specification would be as low as 0.1 mgSi m<sup>-3</sup> but it was set higher due to challenges with measuring such low amount fractions using current commercially available instruments. Hydrogen produced from biogas may contain similar levels of siloxanes depending on the process and purification steps used, and in this case a threshold limit for siloxanes (or total silicon) may need to be incorporated into a UK hydrogen quality standard. Failing to do so could lead to deterioration of appliance performance as would be experienced if siloxanes were present in natural gas. Levels for hydrogen, water and hydrocarbon dew point temperature refer to EN 16726 which is discussed further in EN 16726

### **EN 17124 - Hydrogen fuel - Product specification and quality assurance - Proton exchange membrane (PEM) fuel cell applications for road vehicles [13]**

This is a European standard produced by CEN TC 268 WG5 that provides the fuel quality requirements for hydrogen from the nozzle of a hydrogen refuelling station provided to a PEM fuel cell vehicle. As shown in Appendix A, Table 51, the technical specifications in EN 17124 match very well with ISO 14687 grade D (Appendix A, Table 60). This is due to an effort between ISO TC 197 WG27 and CEN TC 268 WG5 members to harmonise the two standards. Following the 2018 Delegated Act the AFID will replace ISO 14687-2 with EN 17124.

This standard is not relevant for hydrogen provided to homes for heating but would be important to consider should hydrogen in the grid be supplied to hydrogen refuelling stations. EN 17124 was recently accepted and has now been implemented as a BSI standard (BSI EN 17124:2018).

### **ISO 14687 - Hydrogen fuel quality - Product specification [14]**

The first ISO 14687 standard was ISO 14687-1 which was written in 1999. [16] It provided a hydrogen purity specification designed for hydrogen used in “all modes of transportation and hydrogen refuelling applications (ground, water, air and space)”. Over time, two new parts were added to the ISO 14687 series for PEM fuel cell vehicles (ISO 14687-2) [17] and PEM fuel cell stationary appliances (ISO 14687-3). [18] Arguably the most well-known standard in the series is ISO 14687-2 which has become [18] very important for quality assurance of hydrogen used in fuel cell vehicles; the standard was written in the European Directive 2014/94/EU on the deployment of alternative fuels infrastructure (AFID) [19] and therefore became a mandatory requirement for European hydrogen refuelling stations.

More recently, the three ISO standards have been combined to produce ISO 14687. The final draft of this standard was circulated to ISO TC 197 WG27 members in November 2018 with a vote required from all members by 5th December 2018. If accepted, the standard will be publicly available in 2019. A list of the different purity grades shown in the final draft international standard (FDIS) of ISO 14687 is shown in Appendix A, Table 51. [20] Following the 2018 Delegated Act the AFID will replace ISO 14687-2 with EN 17124.

Although the focus of Hy4Heat WP2 is on hydrogen for heat appliances, it should be noted that other UK projects, such as the Hydrogen Gas to Vehicles project (HG2V), is investigating the feasibility of storing and transporting hydrogen in the grid for transport. Hydrogen used for this application would require purity of grade D as shown in Appendix A, Table 52. The purity specification for fuel cell vehicles (either gaseous or liquid hydrogen) is shown in Appendix A Table 60.



PEM fuel cells require extremely pure hydrogen due to the platinum catalysis that drives the reaction. Presence of reactive impurities such as hydrogen sulphide or carbon monoxide can deactivate the catalyst and essentially degrade the entire fuel cell. Additionally, Table 60 includes impurities that may not damage the fuel cell system but compromise integrity of the tank, for example water and particulates.

It is important to note that the technical specification applies to hydrogen produced at the nozzle of the hydrogen refuelling station (opposed to anywhere else within the station). Currently there are only a handful of laboratories that are set up to perform analysis. The National Physical Laboratory in the UK is the only laboratory that is set up to provide these measurements. They will need to ensure they can meet requirements of ISO 21087 which provides criteria for validating the methods for performing ISO 14687 analysis.

Regarding stationary PEM fuel cells, which may apply to combined heat and power (CHP) appliances, the technical specification (Type E) is split into three categories with different purity specifications based on the manufacturers' guidelines Appendix A, Table 60.

As shown in Appendix A, Table 61, category 3 has essentially kept to the same purity specification as Type D, but category's 1 and 2 provide relaxed purities for PEM fuel cells that can run on fuels large amount of non-hydrogen gases. Some micro-CHP appliances may utilise a solid oxide fuel cell, however the ISO 14687 standard does not include a purity specification for this.

Finally, the most relevant section of ISO/FDIS 14687 for Hy4Heat WP2 is the technical specification for applications other than PEM fuel cell road vehicle and stationary applications (shown in Appendix A, Table 61). It should be noted that these purity specifications have not changed since ISO 14687-1 (written in 1999). In 1999, Type I, grade A applied to "internal combustion engines/fuel cell for transportation; residential/commercial appliances" whereas in the new ISO/FDIS 14687 the fuel cell for transportation application has been removed and has become "gaseous hydrogen using for internal combustion engines for transportation, residential or commercial combustion and home appliances (e.g. boilers, cookers and similar applications)".

This is interesting as it suggests that originally Type I, grade A was written to ensure this grade of hydrogen would be suitable for fuel cells which we now know is very sensitive to presence of low level impurities. This suggests that certain specifications such as  $2 \mu\text{mol mol}^{-1}$  may have been included in ISO 14687-1 specifically for fuel cells, whereas now it may not be required. Regarding residential/commercial appliances it should be noted that there is now a clarification that this applies to hydrogen boilers and cookers, whereas previously in the 1999 version this was rather vague. A serious concern is whether or not the relevant stakeholders, such as appliance manufacturers, were consulted during the writing of ISO 14687-1 (1999).

Although grade A is, according to ISO/FDIS 14687, the global recommendation for quality of hydrogen for home appliances such as boilers and cookers, it should not be used as a UK hydrogen quality standard without consultation from relevant UK stakeholders, who can determine which impurities are important to include in the UK standard and the amount fraction threshold (with rationale). Threshold limits of  $2 \mu\text{mol mol}^{-1}$  for total sulphur and  $100 \mu\text{mol mol}^{-1}$  for total hydrocarbons may be too low for combustion applications and as there is no rationale for these limits written into ISO 14687-1, it is difficult to understand why these limits were set. ISO TC 197 WG27 have discussed whether a next action for the working group should be revisit the grade D purity specification and perform a revision according to recent data and consultation from key experts.

It is important to note that very recently normative reference to ISO 21087 was added into ISO 14687 which provides guidance on validating hydrogen purity analysis methods. It is provided as guidance for all grades of hydrogen except Grade D, for which it is mandatory. Currently solid oxide fuel cells are not included in

ISO 14687, and this may be required in future, particularly if CHP appliances utilise SOFC rather than PEM. [20]

## **H21 North of England report**

Whilst it is useful to review existing standards and recommendations on hydrogen purity for home appliances, it is important to understand how viable it would be to produce hydrogen that meets these purity requirements. The H21 North of England report provides expected hydrogen purities for different production processes shown in Appendix A: Table 62.

The report briefly mentions the important consideration of cost; as higher purity requirements may require additional purification steps, and this could considerably increase cost of the process and therefore the price of hydrogen. Therefore, from a cost perspective, lowering the purity requirements would be beneficial.

### **3.1.4 Feedback from Stakeholders**

Stakeholders from relevant organisations or associations within the UK were contacted on 29th November 2018 and provided more than two weeks to comment on their views of what a UK hydrogen quality standard would like this. ISO/FDIS 14687 was provided as a starting point for discussions, and the stakeholders were asked whether they believed this standard was suitable to implement directly as a UK standard for hydrogen quality in the gas grid.

Stakeholders that were contacted included gas networks, energy and safety consultants and equipment manufacturers. This section provides an overview of the feedback received from the stakeholders (shown in **bold**) and this report authors' response (shown in *italics*).

#### **Appliance Manufacturer**

**For ISO 14687 Grade A there is no merit in mixing reactive gases with non-reactive gases, or non-reactive gases with water.**

*A maximum amount fraction limit for total non-reactive gases (such as argon, nitrogen and helium) could be specified as presumably these impurities would not harm the boiler but only reduce energy content and therefore the amount of heat provided. It would be sensible to provide separate specifications for water, oxygen and other reactive impurities such as carbon monoxide and total hydrocarbons as there are different considerations or effects that these impurities will have to operation of a hydrogen boiler.*

**The industry and standards committees will be equally interested in the composition and maximum/minimum concentrations of reactive gases and/or other impurities to establish recommended gas compositions for test gases.**

*This idea may be more applicable to natural gas where the varying levels of hydrocarbons could considerably alter the calorific value, whereas this would not be a concern for 100% hydrogen (particularly if maximum hydrocarbon amount fraction is set around 100  $\mu\text{mol mol}^{-1}$  as specified in ISO 14687). For the purpose of quality assurance, the calibration gases would need to be around the threshold amount fractions to ensure gas analysers are capable of reaching the very low levels required in any future UK standard.*

**Will the specific amount fraction levels for impurities such as oxygen, argon, nitrogen, helium, carbon dioxide and mercury be specified in the future version of ISO 14687?**

*It appears that ISO TC 197 WG27 have agreed to provide combined total amount fraction levels rather than specific maximum amount fraction levels for the individual impurities. This may not be the best approach, and perhaps this should be highlighted as a required change in the future revision of this standard.*

**Should the calorific value and specific density be included in the Grade A specifications?**

If hydrogen purity is set at > 98% presumably there would be a small change in calorific value or specific density should other impurities be present. This may be a more relevant parameter for natural gas where variations in hydrocarbon levels would considerably affect calorific value and specific density.

**The level of carbon monoxide in the standard should be set at around 200  $\mu\text{mol mol}^{-1}$  based on health and safety considerations (i.e. if this is a leak that reaches a civilian). Any level higher than this could be dangerous, and any lower would be unnecessary (except for fuel cell applications).**

*There is little information regarding the recommended level of carbon monoxide in hydrogen supplied to appliances, so this is a good starting point for us. The H21 project has recommended 15  $\mu\text{mol mol}^{-1}$ , but this is based on fuel cell requirements, so not relevant for appliances. We can set the carbon monoxide specification at 200  $\mu\text{mol mol}^{-1}$  until other information is obtained.*

**Water at high levels could potentially condense out of the gas so the same maximum level as GSMR1996 would be suitable.**

*The water dew point of  $-80^{\circ}\text{C}$  is specified in EASEE-gas specifications and EN 16726. ISO 14687 Grade A only mentions that water should not condense and GSMR1996 that water should "not interfere with the integrity or operation of pipes or any gas appliance". So, a set limit of  $-80^{\circ}\text{C}$  would be suitable.*

**Methane, carbon dioxide and hydrocarbons are not expected to be an issue with regards to reactivity.**

*It may be possible to include a maximum amount fraction for these parameters based on limiting carbon content of the exhaust.*

**Oxygen must be reduced for safety reasons.**

*GSMR1996 has set oxygen at a maximum of 0.2% which according to ISO 10156 would be safe (even in hydrogen rather than natural gas).*

### **Safety Consultant**

**We would expect that any hydrogen supplied for use in domestic appliances etc. is of a suitable composition and quality to ensure the safety of the end user when the hydrogen is burnt, both in terms of combustion characteristics and potential effect (short and long-term) on the performance of the appliance. It will be the duty holder's responsibility to provide evidence to us that that is the case.**

*The list of impurities and levels selected in this study will be based on safety and lifetime of the appliance.*

**Regarding an odorant for hydrogen, our position is that the odorant needs to have a distinctive smell which is recognisable on a gas leak and is equally effective as the current odorant in terms of members of the public reporting gas escapes. Clearly this is easier to demonstrate if the odorant is similar to that currently used - if an alternative odorant is selected then the demonstration of similar effectiveness would need to be made.**

*SGN's Hydrogen 100 project (Hydrogen Odorants and Leak Detection), which is led by NPL, is investigating new odorants for a 100% hydrogen grid in the UK. It is likely that the odorant for hydrogen will be the same as the current one used in natural gas (Odorant NB) or a similar sulphur-containing compound. Therefore, the same limits for total sulphur would be viable. These odorants would not be compatible with a fuel cell vehicle.*



**The CO level is above the exposure limits (ten times the long term limit). Presumably they are allowing for some dilution in air rather than someone directly breathing in the gas. At 10% dilution, the gas would still be flammable so its toxicity would very much be a secondary concern.**

*This comment aligns with the output from this study. There is a balance with regard to clean-up cost and achievable low-level CO concentration. In determining the 200 ppm CO limit, it has been assumed that dilution in air will mitigate this risk and as noted the flammability risk is greater than that for CO exposure.*

### **Hydrogen Producer**

**The combustion issues include: safe ignition; flame failure sensing and minimising indoor explosion hazards if burners are operated without ignition; minimising 'flashback' when turning burners down and the effectiveness of flame arresters; open flames and their very poor visibility and emissivity.**

*These are very important considerations that appliance manufacturers must be aware of when developing new appliances operating on hydrogen.*

**It should be noted that the specifications in Grade A of ISO 14687-1 was actually the old fuel cell grade, so this is massively overkill for hydrogen combustion. As no one in ISO TC 197 WG27 suggested alternative specifications it remained. This should be taken as an informative grade.**

*This point is noted, and for this reason the new recommendations for a hydrogen quality standard will probably not be influenced by this standard.*

**For the water dewpoint, maybe it would be better stated as "non-condensing at -10 °C under expected operating conditions"? (or something like "Non-condensing at all ambient conditions", which is what is used for Grade E hydrogen when we prepared ISO 14687-3) I.e. it is assumed that the ppm permitted will differ depending on whether it is transmission or distribution network, and there is a significant difference in pressure?...or does it need a worst case assumption?**

### **Energy Consultant**

**What should be focused on is the level of impurities, especially the CO content. The risk profile for the transportation of gas must be acceptable and comparable to natural gas, which currently does not contain CO and therefore does not result in a CO risk. The level of CO should be kept within HSE guidelines based on international standards of exposure levels, to ensure a potential leak in the network does not result in an exposure risk to the public and repair operatives.**

*Carbon monoxide will be included in the recommendations in this report and will be based on exposure levels.*

**If the UK is ever to convert to hydrogen, this opens up the opportunity for its use in vehicles (as highlighted in the recent hydrogen report from the Committee on Climate Change), and so the needs of this market need to be considered.**

*A purity specification for hydrogen fuel cell vehicles has already been published (ISO 14687 Grade D) based on sound evidence and good agreement between countries in its development (including the UK). Therefore, it is likely that we will recommend ISO 14687 Grade D as the purity requirements for fuel cell vehicles unless projects such as the Cadent Gas Hydrogen Grid to Vehicles project identifies any required modifications.*

### **Energy Consultant**

**Water content in pipelines needs to be managed so that liquid water does not drop out and impact on the pipeline integrity and operations. A water dewpoint limit would be appropriate and must**

**link to the operating pressure of the pipeline. This water dewpoint limit for natural gas is -10 °C at 85 bar and it is suggested that this is adopted for pipeline hydrogen too.**

*This approach agrees with the documents reviewed in this report.*

**For hydrocarbon dewpoint, a similar approach is taken to water dewpoint and the limit is -2 °C at 85 bar, and again it is suggested that this is included. This would provide an additional constraint on the hydrocarbon concentration limit as the dewpoint is dependent on the hydrocarbon speciation.**

*This approach agrees with the documents reviewed in this report.*

**If the current sulphur-based odorant is adopted for pipeline hydrogen, then the 2.0 µmol mol<sup>-1</sup> may be breached as the odorant addition is typically around 6 mg m<sup>-3</sup> but may be more in some situations.**

*We have noted that the total sulphur limits in GSMR 1996 and ISO 14687 Grade A do not agree. As ISO 14687 Grade A was originally written for fuel cells and the UK industry is already familiar with GSMR1996, it would make sense to keep the total sulphur level the same as in GSMR1996.*

**The general statement in GSMR1996 for pipeline natural gas could be adopted for pipeline hydrogen - The gas shall not contain solid, liquid or gaseous material that might interfere with the integrity or operation of pipes or any gas appliance, within the meaning of regulation 2(1) of the Gas Safety (Installation and Use) Regulations 1998, that a consumer could reasonably be expected to operate.**

*This statement is still valid and should be included.*

### **Gas Network**

**The H21 NoE reports that hydrogen from SMR processes may provide purity of 97.5% which would not meet ISO 14687 Grade A. Should a low amount fraction, for instance 95-96%, be more appropriate?**

*This is something we have considered. If there is no issue for boilers to run at 95% hydrogen, then this would make sense. This will need to be investigated further, and link with the cost:benefit analysis. Lower hydrogen content would automatically lead to an increase in concentration of other components and this requires further consideration.*

**Conversely, allowing a low amount fraction of hydrogen may lead to high levels of carbon dioxide; should there be a maximum level for carbon dioxide based on appliance operation and climate change requirements?**

*Currently there are no UK regulations that can provide guidance for carbon dioxide emission limits, so an initial limit of 5% may be acceptable (with an anticipated reduction later on). Natural gas pipelines tend to limit the carbon dioxide content and the limit could be based on these recommendations. A limit of 2.5 mol% is commonly applied although higher values may be worthy of further consideration.*

**The permissible oxygen level may have lifted (via exemption) for biomethane entry, should this be considered?**

*Hydrogen production processes should not have trouble limiting oxygen to 0.2%, but the absolute limit may require further consideration (see comment from WWU below).*

**Do we have enough evidence to keep the same water dewpoint as for GSMR 1996?**

*We expected water condensation to behave the same in hydrogen and natural gas.*

**Carbon monoxide and methane may be difficult to reduce for hydrogen produced by autothermal reforming and steam methane reforming.**

*Carbon monoxide in particular may be an issue for hydrogen production processes, so this will need to be investigated.*

**Does a separate specification need to be written if the hydrogen was to be provided to fuel cell systems?**

*This is very likely. More work will be carried out by the HG2V project which will help us understand possible impurities that can be produced from hydrogen production or contact with old pipelines, and if the specification would be the same as ISO 14687 Grade D.*

**Given production process of hydrogen vary are there other compounds or gases that we currently do not see in the system which may creep in?**

*This will be addressed by the HG2V project.*

**Engine Manufacturer**

**We would like to see the sulphur content <10ppm to fall in line with current diesel. This would allow catalysts to be used in exhaust systems for SCR. It would be nice but not essential to reduce the carbon level to below 1%, but H<sub>2</sub> cost is more important to us than 1% CO<sub>2</sub>.**

*This report is investigating hydrogen for heat applications and further modifications to the specifications may be required if it is clear that the hydrogen will be used for hydrogen internal combustion engines in the UK.*

**Although the specification would meet the minimum purity specifications for hydrogen combustion vehicles, it will not be suitable for Hydrogen Fuel Cells.**

*This is noted; a separate specification may be required specifically for hydrogen fuel cell vehicles.*

**Gas Network**

**From an initial review the only current query is around the oxygen content – the justification given in the table is that the detrimental effects of oxygen would be similar to current, however as you are aware GS(M)R currently allow distribution (<38barg) networks to operate to 1% oxygen content as it was shown that the additional increase in risk / impact on the network from this increase in oxygen content in gas was negligible. Whilst obviously in a pure hydrogen network the primary rationale around this current exemption - biomethane injection, is likely to be absent, however is there additional reasoning why the proposed oxygen limit is being maintained at  $\leq 0.2 \text{ cmol mol}^{-1}$ ? Could there not be a potential benefit to maintain a 1% limit for distribution systems potentially supporting alternative hydrogen sources (bio-hydrogen?) in much the same way we accommodate biomethane currently?**

*Although the concentration of oxygen in hydrogen produced by most large-scale methods is expected to be low, the limit should be able to accommodate other more novel methods. Bio-hydrogen is a production method akin to biomethane and may result in higher oxygen content. This will be considered as part of the on-going project but at the present time a limit of  $0.2 \text{ cmol mol}^{-1}$  is the proposed value.*

## **Fuel Cell Vehicle Manufacturer**

**“Pretty much everything is too high. “Water is probably too high for compression and O<sub>2</sub> and hydrocarbons look above spec too - although the impacts are poorly understood.**

**But particularly H<sub>2</sub>S and other sulphur. This is highly detrimental and the spec for fuel cells is around 1-2ppb so the value is about 2\*10<sup>3</sup> too high.**

**CO is also high - by a factor of 100 - and where there is more flexibility and CO poisoning can be partially recoverable these levels are not compatible. Spec is <1ppm but with some flexibility in practice for temporary fluctuations above that.**

**Some more clean-up is required certainly what is interesting to explore is the cheap routes to doing this and managing the quality assurance in a cost-effective way. Guarantees are probably expensive, measurement and mitigation possibly cheaper.**

### **3.1.5 Recommendations**

The literature review undertaken would suggest that there is already a lot of useful information or guidance on quality recommendations for hydrogen used for heating, but most of the documents reviewed are specifically for natural gas, biomethane or hydrogen for PEM fuel cell applications.

The only relevant documentary standard that provides recommended hydrogen quality for heat applications is ISO/FDIS 14687 which includes a Grade A specification for appliances such as hydrogen boilers and cookers. However, as previously mentioned in this report and highlighted by the stakeholder’s comments from the previous section, the Grade A specification is not fit-for-purpose as it may have been originally based on PEM fuel cell applications and not included input from appliance manufacturers.

Therefore, a draft recommendation based on this study for Hy4Heat WP2 is shown in Table 1, **which recommends a minimum purity standard** (i.e. the purity of the delivered hydrogen should lie between 98 and 100%, and the value detailed in the specification documentation), based on considerations from existing quality recommendations for natural gas, possible new impurities from hydrogen production processes and feedback from stakeholders.

Content or characteristic	Value	Rationale
Hydrogen fuel index (minimum mole fraction)	98 % ( $\text{cmol mol}^{-1}$ )	This value is a good compromise between hydrogen cost and effects on boiler.
Carbon Monoxide	20 ppm ( $\mu\text{mol mol}^{-1}$ )	A practical engineering limit based on achievable production limits and to meet long term exposure limits HSE EH/40)
Hydrogen sulphide content	$\leq 5 \text{ mg m}^{-3}$ 3.5 ppm ( $\mu\text{mol mol}^{-1}$ )	These values are taken from GSMR:1996 as any detrimental effects would be similar for hydrogen and natural gas, in a repurposed pipeline network.
Total sulphur content (including $\text{H}_2\text{S}$ )	$\leq 50 \text{ mg m}^{-3}$ 35 ppm ( $\mu\text{mol mol}^{-1}$ )	
Oxygen content	$\leq 0.2 \%$ ( $\text{cmol mol}^{-1}$ )	
Hydrocarbon dewpoint	-2 °C	Complies with GSMR:1996 and EASEE-gas, and avoids liquid drop-out
Water dewpoint	-10 °C	
Sum of methane, carbon dioxide and total hydrocarbons	$\leq 1 \%$ ( $\text{cmol mol}^{-1}$ )	No detrimental effects to boiler, this limit is to reduce carbon content of the exhaust
Sum of argon, nitrogen and helium	$\leq 2 \%$ ( $\text{cmol mol}^{-1}$ )	To avoid transporting inert gases with no calorific value in the hydrogen gas (in agreement with ISO/FDIS 14687) and to limit the impact on Wobbe Number (see below)
Wobbe Number range	42 – 46 $\text{MJ m}^{-3}$	Range and percentage variation based on natural gas range in GSMR1996  Wobbe Number is calculated at UK metric standard conditions of 15 °C and 101.325 kPa
Other impurities	The gas shall not contain solid, liquid or gaseous material that might interfere with the integrity or operation of pipes or any gas appliance, within the meaning of regulation 2(1) of the Gas Safety (Installation and Use) Regulations 1998, that a consumer could reasonably be expected to operate	

**Table 1: Draft recommendation for a UK hydrogen quality standard for heat applications based on existing standards and documents**

If hydrogen from the grid is provided to a hydrogen refuelling station supplying fuel cell vehicles, the authors would recommend that EN 17124 is followed once this normative reference is added into the AFID.



The **hydrogen content** in the purity standard has been discussed with stakeholders (hydrogen producers, domestic appliance manufacturers, fuel cell manufacturers, GDNO's) and the 98% minimum hydrogen content is viewed as a reasonable and pragmatic value. The range and quantity of trace components reflects those from existing hydrogen standards and ones from existing natural gas quality requirements.

The overall view is that large scale hydrogen production systems can produce hydrogen purity to meet these limits and that the concentration of the trace components will not impact on the overall hydrogen fuel utilisation in traditional domestic appliance designs (albeit ones that are suitable for hydrogen use).

**Carbon monoxide** limits have received the most significant stakeholder feedback and a limit of 20 ppm is proposed as the target value for the Hy4Heat unoccupied and occupied field trials.

The rationale for this limit is that it is a balance between the practicality for achieving the desired purity as well as the impact on cost (and maintaining several purification technology options), together with ensuring that exposure to carbon monoxide is within the current HSE EH/40 occupational health guidelines.

**Total Sulphur Content** is akin to that for the current natural gas pipeline limits (as set out in the GS(M)R and includes consideration of the sulphur content of odorant, the sulphur that may be adsorbed onto internal pipe walls and any sulphur introduction through the hydrogen production process. As the current limit is achievable for natural gas, it is not anticipated to be a barrier for hydrogen pipeline networks.

The current standard for sulphur compounds at 35 ppm is not suitable for solid oxide fuel cell CHP (SOFC CHP) or PEM fuel cell CHP (PEMFC CHP) which require less than 1  $\mu\text{mol}/\text{mol}^1$  and 0.004  $\mu\text{mol}/\text{mol}^2$  of sulphur compounds respectively. At the standard set, SOFC and PEMFC users would require a desulphuriser.

The cost of a desulphuriser is dependent upon the sulphur level to be removed and hydrogen throughput but purifying from 20 to 1 ppm for a  $\mu\text{CHP}$  user, for example, could cost an additional £34-39 annually.

Hydrogen produced both from natural gas by reformation and electrolysis is anticipated to have less than 0.05  $\mu\text{mol}/\text{mol}$  sulphur compounds, and so with a network that doesn't introduce impurities the level of sulphur specified could be reduced

The **oxygen content** limit relates to the management of internal corrosion of the pipe and ensuring pipeline integrity. Although it is recognised that for accelerated corrosion the presence of both water and oxygen is required, it is deemed appropriate to adopt a current natural gas limit for oxygen content. This limit does not impact on hydrogen production costs and can be met readily.

**Dewpoint** limits for both water and hydrocarbons are included in the specification to avoid formation of a liquid phase in the pipe. Two phase flow in pipelines must be avoided for operational reasons and the limits for natural gas in threw UK are proposed as suitable values for hydrogen networks.

The **sum of hydrocarbons** limit relates to two aspects. The first is that the carbon content of the hydrogen fuel, should be minimised to ensure that the maximum carbon emission reduction is obtained; and the second is that the presence of hydrocarbons above this limit could impact on the utilisation, especially in low temperature fuel cells.

**Sum of inert gases** limits have been included to avoid significant impact on the Wobbe Number and transportation of gas with no calorific value which will add cost but no benefit to the end user. The limits have been proposed based on achievable levels from production processes.

---

<sup>1</sup> Discussion with a stakeholder

<sup>2</sup> 2ISO/DIS 14687 standard for PEM fuel cell stationary applications Type I, grade E category 3

**Wobbe Number** has been included in the specification to meet the requirements from traditional burner manufacturers and is an important aspect as the variation can be significant if heavier trace components like carbon dioxide are present.

Stakeholder engagement on hydrogen purity requirements with a leading appliance manufacturer, hydrogen producer, gas network operator, the HSE and energy consultancy companies endorsed the hydrogen purity recommendation shown above.

### 3.2 Implications of the Proposed Hydrogen Purity Standard

This section comments on the implications of the proposed hydrogen purity standard shown in Table 1 from the perspective of the hydrogen production and purification technologies currently available. The implications are that:

- Hydrogen produced by electrolysis and then dried will meet this standard.
- Hydrogen produced by an ATR or an SMR, with carbon capture and no further purification, would not meet this standard due to both:
  - higher carbon monoxide levels, and
  - a higher sum of methane, carbon dioxide and total hydrocarbon content, than the standard specifies.

Example levels of impurities found in SMR and ATR produced hydrogen are displayed in Table 3.

Impurity	SMR (dry mol%)	Oxygen-Fed ATR (dry mol %)
CO	0.1-4	0.3-2
CO <sub>2</sub>	0.35-0.7	0.7-1.7
CH <sub>4</sub>	3.5-8	0.3-3
N <sub>2</sub>	0-0.3	0.7
Ar	0	0.6
H <sub>2</sub> O	<0.03 – 0.4	<0.03 – 0.4
O <sub>2</sub>	0	0
H <sub>2</sub> S	< 50 x10 <sup>-4</sup>	< 50 x10 <sup>-4</sup>

**Table 3: Range of impurity levels for hydrogen produced by a reformer with carbon capture.**

Methanation or pressure swing adsorption (PSA) are the two currently available technologies that could be used to reduce carbon monoxide safe levels. The technologies that could be used to reach varying carbon monoxide levels are displayed in Table 4 (see also Table 6).

CO level (ppm)	Technology currently commercially available to reach level of purity stated?	
	Methanation	PSA
200	Yes	Yes
100	Yes	Yes
10	Yes	Yes
1	No	Yes
0.2	No	Yes

**Table 4: Suitability of methanation and PSA for various target levels of CO**

PSA is the industry standard for hydrogen purification and can reduce all other impurity levels to the levels in this proposed standard. Methanation can be used to reduce carbon monoxide to safe levels, by reacting CO with hydrogen to produce methane. Methanation can reduce CO levels to less than 10 ppm [121], for example, using Johnson Matthey catalysts [122].

If very low levels of CO<sub>2</sub> emissions are sought, leading to the use of hydrogen in the fired heater that feeds the reformer (as shown in Figure 13), then PSA can offer a similar cost method for reducing carbon monoxide levels than methanation for any level of CO at or above 10 ppm (for levels lower than this, methanation is not an option as shown in Table 4).

In contrast, methanation offers a lower cost purification option for reaching carbon monoxide levels of 10 ppm or higher in cases where natural gas is used in the fired heater that feeds the reformer (as shown in Figure 14). The cost comparisons of methanation and PSA are shown Figure 52 and Figure 54.

However, the limit in the proposed hydrogen purity standard of 1 cmol/mol on the sum of carbon monoxide, carbon dioxide and total hydrocarbons levels limits the case in which methanation can be used as a purification option. In a syngas with x cmol/mol CO and y cmol/mol CO<sub>2</sub>, x+y cmol/mol CH<sub>4</sub> is produced by the methanation reaction, and so the sum of carbon monoxide, carbon dioxide and methane is not reduced by methanation. The syngases produced by SMRs in Table therefore cannot reach the 1 cmol/mol specification if methanation is used for purification.

ATR produced hydrogen can reach this 1 cmol/mol level if the reformer is designed to produce low levels of CH<sub>4</sub>, CO and CO<sub>2</sub>. For example, the H21 design would produce 0.4-0.6 cmol/mol CO and 0.2-0.4 cmol/mol CH<sub>4</sub>. If the carbon capture rate is high (higher than the 98% assumed in the report), then the methanation reaction will produce ~0.6-1.0 cmol/mol CH<sub>4</sub> and the limit is achieved.

Table 37 shows that the cost of using a PSA to reach safe levels of CO does not add a significant cost to hydrogen production, adding a cost of order ~0.1-0.2 p/kWh. Figure 43, Figure 44 and Figure 46 demonstrate the additional costs of producing hydrogen to decreasing levels of carbon monoxide using PSA.

### 3.3 Production and Purification Methods

This section of the report reviews hydrogen production methods, including their practical feasibility and economics, and focuses on the type and quantity of the resulting impurities. This review is intended to inform sub task 2d, a cost benefit analysis of the hydrogen purity options. This document also indicates where data gaps remain.

The structure of this section of the report is as follows:



- Section 3.2.1 summarises the production routes we propose for consideration in the cost benefit analysis (sub task 2d), and the cost and impurity information gathered for each.
- Section 3.2.2 outlines the impact of impurities on end-users
- Section 3.2.3 provides detail on various production methods and compatible purification technologies, including:
  - Production of hydrogen from hydrocarbon sources is outlined
  - Compatible purification steps
  - For each technology an overview is first presented, followed by data found in the literature on costs and impurities.
  - A brief overview of by-product hydrogen production is presented
- Section 3.2.4 presents a picture of current hydrogen production in the UK.
- Section 3.2.5 describes several key projects in the literature which present a view on appropriate hydrogen purity levels for various applications.

### 3.3.1 Hydrogen Production Routes to consider

Various hydrogen production and purification methods are described in this report, alongside an assessment of the impurities typically found in the hydrogen produced and costs associated with the production method. Here, we summarise the key hydrogen production routes we propose for consideration in the cost benefit analysis (sub task 2c).

The following hydrogen production routes selected (summarised in Figure 13)

- A) Reformer + Water Gas Shift (WGS) + Amine Wash
- B) Reformer + WGS + Amine Wash + Methanation
- C) Reformer + WGS + Amine Wash + Pressure Swing Adsorption (PSA)
- D) Reformer + WGS + Amine Wash + Polymer Membrane
- E) Electrolysis
- F) Electrolysis + Temperature Swing Adsorption

(A) Reformer + WGS + Amine Wash

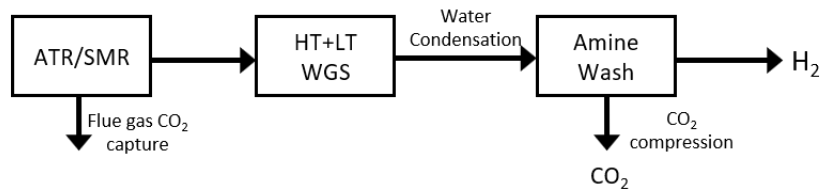

(B) Reformer + WGS + Amine Wash + Methanation

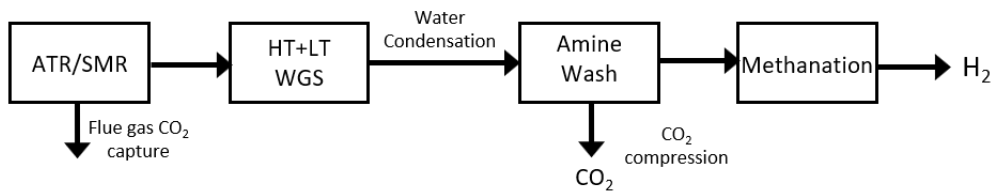

(C) Reformer + WGS + Amine Wash + PSA

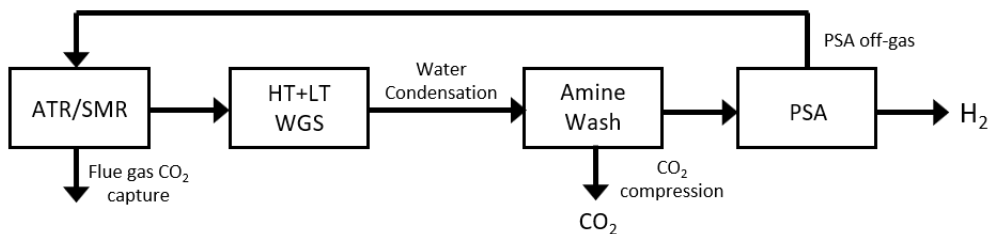

(D) Reformer + WGS + Amine Wash + Polymer Membrane

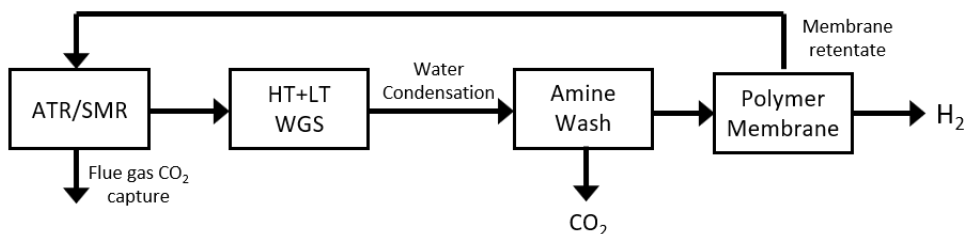

(E) Electrolysis

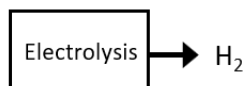

(F) Electrolysis + TSA

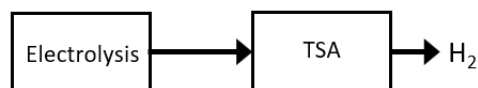

**Figure 2: Hydrogen production routes to consider in the cost-benefit analysis. Electrolysis may be alkaline electrolysis or proton exchange membrane electrolysis.**

Four production methods are not selected for separate consideration in the cost-benefit analysis, including:

- **Gas Heated Reformation (GHR)** - GHR is not considered separately as the impurities found will lie between those of an autothermal reformer (ATR) and steam methane reformer (SMR).
- **Partial Oxidation (POx)** - POx is not selected due to its reduced efficiency compared to an ATR and its tendency for usage with heavier feedstock than natural gas
- **Coal gasification** - Coal gasification is not taken forward due to its higher cost and carbon emissions than an SMR or ATR.
- **Biomass/waste gasification** - Biomass/waste gasification is not considered separately due to a current shortage of commercial demonstration case studies and associated impurity data.

Three hydrogen purification steps are not included among the proposed routes, including:

- **Palladium membrane diffusion** - Palladium membranes come in two forms; pure palladium membranes and supported palladium membranes. Pure palladium membranes are traditionally used for relatively small-scale hydrogen purification in the electronics industry. The membranes have high capital costs and provide low hydrogen fluxes and are therefore not considered further here.

Membranes where palladium is supported by another material, such as steel or ceramic offer higher hydrogen fluxes and reduced capital costs. A discussion with a stakeholder noted these have a technology readiness level (TRL) of 5-6 and so are not recommended for consideration in the cost benefit analysis.

We note here that if supported palladium membranes were to become commercially available, they would be expected to provide hydrogen at a purity that meets the ISO 14687 vehicle PEMFC standard and so would also meet any less stringent standard.

- **Cryogenic purification technologies** - Cryogenic separation is considered as a potential alternative for CO<sub>2</sub> capture, rather than for purification. Examples of cryogenic technologies being used for carbon capture are previously discussed in this report. We did not however find any demonstrations of cryogenic technologies being used for hydrogen purification from synthesis gas. A stakeholder also noted that cryogenics may not be very effective in removing carbon monoxide and water, and so may be more suitable for bulk separation with further purification downstream.
- **Electrochemical purification technologies** - Electrochemical technologies are not considered further here due to their TRL and the fact that, to date, they have not been demonstrated for large scale hydrogen purification. Electrochemical purification has so far been trialled in systems targeting the recovery of hydrogen used in industrial processes and the recovery of hydrogen from natural gas grids at 2 -10 % hydrogen concentration.

The selected production routes are described further below. More detail on each production and purification technology is presented in the main report.

### (A) Reformer + WGS + Amine Wash

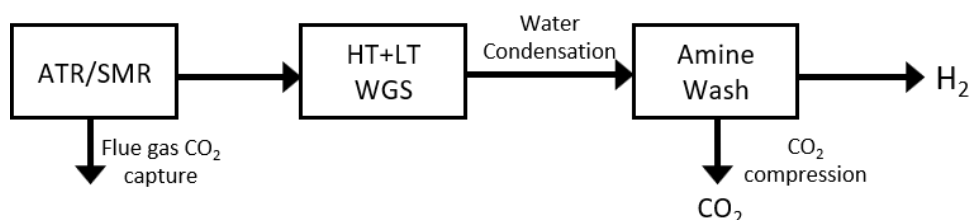

This method consists of production of hydrogen by a reformer, followed by water gas shift reactions and carbon capture from the syngas using an amine wash. Carbon capture is required for hydrogen production from fossil fuels to be low-carbon, and so this is considered the 'base case' for the cost benefit analysis. This method, using an oxygen-blown ATR, is recommended by the H21 NoE study [21].

In an SMR, only 60% of the CO<sub>2</sub> emissions can be captured from the syngas [22], and the rest must be captured from the burner flue gas. In an ATR, all the CO<sub>2</sub> is found in the syngas. In an SMR, the capture (or not) of CO<sub>2</sub> from the flue gas does not affect the purity of hydrogen produced.

#### Impurity levels

The range of impurity levels observed for this flow scheme are displayed in Table 5. These figures are calculated using syngas compositions after the water gas shift reaction and assuming 98% CO<sub>2</sub> capture from the syngas. The catalysts used in reformers are poisoned irreversibly by sulphur compounds. A study of contaminants in hydrogen [23] found that sulphur is removed completely before reformation and feedstock pre-treatment is designed to reduce H<sub>2</sub>S to less than 50 ppm, reaching less than 10 ppm in practice.

#### Cost Data

MDEA, used in an amine wash for CO<sub>2</sub> capture from the syngas of an SMR, is estimated to require an additional cost of 0.6 p per kWh (values converted from euros using exchange rate on 17.1.19: €1 = £0.88) of hydrogen produced [24], [22]. We note that this captures 60 % of the CO<sub>2</sub> emitted, and the cost without carbon capture is estimated to be 3.3 p/kWh [24]. A total cost of hydrogen of 5 p/kWh, including carbon capture of 94% of the CO<sub>2</sub> produced, is given in the H21 report for an ATR [21].

Impurity	SMR (dry mol%)	Oxygen-Fed ATR (dry mol %)	Air-Fed ATR (dry mol %)
CO	0.1-4	0.3-2	0.6-0.7
CO <sub>2</sub>	0.35-0.7	0.7-1.7	0.4
CH <sub>4</sub>	3.5-8	0.3-3	0.08-0.4
N <sub>2</sub>	0-0.3	0.7	23-46
Ar	0	0.6	0.5-0.6
H <sub>2</sub> O	<0.03 – 0.4	<0.03 – 0.4	<0.03-0.4
O <sub>2</sub>	0	0	0
H <sub>2</sub> S	< 50 x10 <sup>-4</sup>	< 50 x10 <sup>-4</sup>	< 50 x10 <sup>-4</sup>

**Table 5: Range of impurity levels for hydrogen produced by a reformer with carbon capture.**

## (B) Reformer + WGS + Amine Wash + Methanation

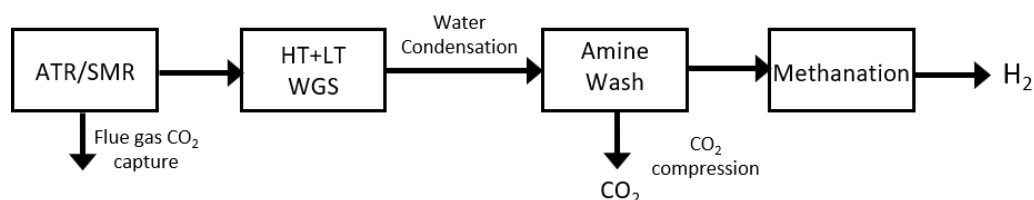

This method of hydrogen production was commonly used, without the CO<sub>2</sub> being compressed for capture, prior to the commercialisation of pressure swing adsorption. [25] It is the same as case (A), with the addition of the methanation reaction to remove carbon monoxide. The Biohydrogen project report [26] suggests using methanation for reducing CO after carbon capture in hydrogen produced from waste.

### Impurity Levels

The reaction can reduce CO levels down to 10-50 ppm. The range of impurity levels expected post-methanation are shown in Table 16. These values are calculated using the values in Table 6, considering the stoichiometry of the methanation reaction and assuming the methanation reaction reduces CO levels to 50 ppm.

### Cost Data

The cost of the methanation reaction is still to be confirmed in further discussions with stakeholders. Operating costs will include the cost of re-heating hydrogen to the temperature of the methanation reaction (which may be achievable with waste heat), and a loss of three hydrogen molecules for every molecule of carbon monoxide removed.

Impurity	SMR (dry mol%)	Oxygen-Fed ATR (dry mol %)	Air-Fed ATR (dry mol %)
CO	10 - 50 × 10 <sup>-4</sup>	10 - 50 × 10 <sup>-4</sup>	10 - 50 × 10 <sup>-4</sup>
CO <sub>2</sub>	0.35-0.8	0.7-1.7	0.4
CH <sub>4</sub>	3.6-14	0.6-3	0.7-1.1
N <sub>2</sub>	0 - 0.3	0.7	23-47
Ar	0	0.6	0.5-0.6
H <sub>2</sub> O	<0.03 - 0.4	<0.03 - 0.4	<0.03 - 0.4
O <sub>2</sub>	0	0	0
H <sub>2</sub> S	< 50 × 10 <sup>-4</sup>	< 50 × 10 <sup>-4</sup>	< 50 × 10 <sup>-4</sup>

**Table 6: Range of impurity levels expected after a methanation reaction**

### (C) Reformer + WGS + Amine Wash + PSA

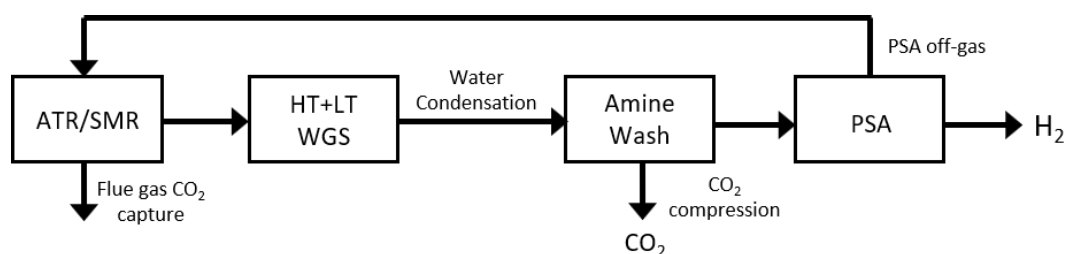

Pressure swing adsorption is the current industry standard for purifying hydrogen produced by a fossil fuel, but carbon capture is not yet widely practised. There are examples of carbon capture plants in Concon in Chile and the Shell Quest project in Alberta, Canada. Each of these examples use an amine wash for carbon capture before using PSA.

#### Impurity Levels

Hydrogen purified by PSA can meet the ISO 14687 standard for vehicle PEMFC.

#### Cost Data

PSA typically causes a ~10% loss of hydrogen product, which is usually combusted in the place of natural gas to provide heat for the hydrogen production process. The impact that this has on the overall efficiency of hydrogen production is unclear. The H21 report [21] models a 10% lower efficiency for an SMR with a PSA compared to an SMR without a PSA, while a stakeholder noted that a flow scheme with methanation and a flow scheme with PSA have the approximately the same efficiency. These differences will be clarified in further discussions with stakeholders.

PSA is driven by the pressure from the reformation reaction, and so has negligible other operating costs (except for maintenance and repair).

The H21 project [21] estimated a total project cost of £122 million for a PSA that produces 282,000 Nm<sup>3</sup>/hr of pure hydrogen (1 GW). According to a conversation with a stakeholder, the capital cost of a PSA unit is in the upper single digit percentages of the total plant cost (i.e. we assume around 8-10% of total plant cost). The capital cost of the reformer will also increase if a PSA is used, as a ~11% higher production capacity will be required in order to maintain the same hydrogen output.

### (D) Reformer + WGS + Amine Wash + Polymer Membrane

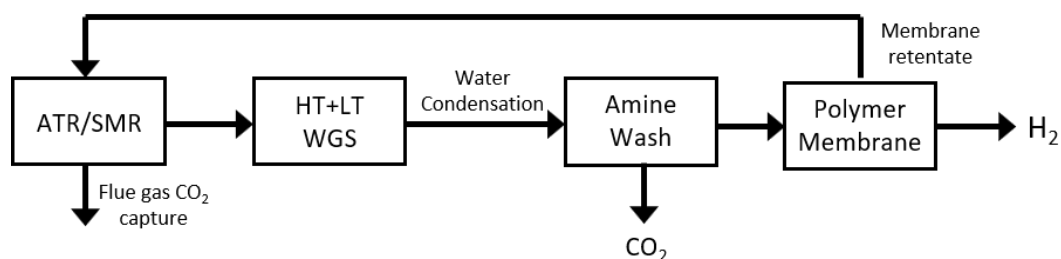

Polymer-based membranes have been used commercially for the separation of hydrogen from various refinery, petrochemical and chemical process streams. Air Products sells the PRISM membrane [27], Honeywell UOP sell the Polysep membrane [8], Air Liquide offer the ALaS membrane [29] and Linde the HISELECT membrane [30].

During the preparation of this report, further information has been received from a stakeholder clarifying the suitability of polymer membranes for syngas purification. This stakeholder suggested that Linde's polymer membrane would not be suitable for this application. We also note that the Honeywell UOP membrane requires at least 70 bar feed pressure, higher than the normal pressures in both ATRs and SMRs. Alongside this, each of the membrane products mentioned above target refinery and petrochemical applications. We therefore do not suggest considering polymer membranes further as a purification option in the cost benefit analysis.

### Impurity Levels

A discussion with a stakeholder suggested that roughly 5-10% of the carbon monoxide would remain in the hydrogen stream, leaving carbon monoxide levels in the range of 50-4000 ppm based upon the values in Table 5. Some methane and inert gases would also be removed by the membrane.

### Cost Data

The capital costs of a polymer membrane are unclear, but are noted to be low in the literature. [31] [32] The operating costs of a polymer membrane will include a loss of the hydrogen product, between 2-15% for membranes examined. Membranes also produce hydrogen at reduced pressure, compared to the 20 – 50 bar hydrogen produced by other reformation routes. There will hence be the additional cost of compressing hydrogen for injection into the grid if a polymer membrane is used for purification.

### (E) Electrolysis

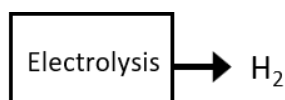

Electrolysis is usually combined with a temperature swing adsorber in order to remove water and oxygen from the hydrogen product. We consider this case to see if the hydrogen produced without a TSA is pure enough for heating applications. Either proton exchange membrane (PEM) electrolysis or alkaline electrolysis (AEL) could be used.

### Impurity Levels

The impurities found in hydrogen produced by PEMWE without TSA are presented in Table 7. In AEL, oxygen can be reduced to 50 ppm and water levels of >100 ppm are expected. The water found in hydrogen produced by AEL is expected to contain either the K<sup>+</sup> or Na<sup>+</sup> ions found in the alkaline conducting solution.

### Cost Data

The cost of hydrogen produced by AEL is estimated to be 15.5p /kWh by the H21 report [21] and the cost of hydrogen produced PEMWE is anticipated by UKHFC [33] to be 16 p/kWh in 2025. These values include the TSA step.

Impurity	Impurity Level
H <sub>2</sub> O	>100 ppm
O <sub>2</sub>	18-500 ppm
CO <sub>2</sub>	0.2-5.4 ppm
Inert gases	Within ISO 14687 Vehicle PEMFC limit

**Table 7: Impurities found in hydrogen produced by PEMWE**

## (F) Electrolysis + TSA

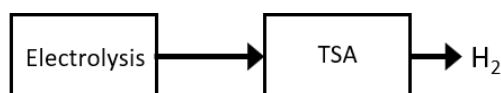

TSA, including a catalytic de-oxygenation step, is the current standard practice for drying electrolysis-produced hydrogen.

### Impurity Levels

Hydrogen produced through this process, using both PEMWE and AEL, can meet the ISO 14867 vehicle PEMWE standard.

### Cost Data

The capital cost of a TSA unit was estimated in discussions with stakeholders to be approximately 5% of the capital cost of the electrolyser. In terms of operating costs, the TSA unit is stated in a techno-economic analysis of PEM electrolysis by [34] to use 1.25 kWh electricity per kg H<sub>2</sub> produced, and to use 3-4% of the hydrogen product for regeneration.

## 3.3.2 Impact of Impurities on End Users

In this section, tentative acceptable levels of selected impurities are outlined for different end uses. The results of sub task 2a will be used to inform these levels. The impurities selected are those anticipated to be found in hydrogen production.

The applications considered here are:

- Vehicle proton exchange membrane fuel cells (PEMFC)
- Stationary PEMFC
- Pipes
- Traditional burners for boilers
- Traditional burners for cookers (e.g. gas hobs, ovens and grills).

PEMFC have high purity specifications and so are included here. In the ISO 14687 standard, different specifications are given for stationary and vehicle PEMFC and so they are considered separately. Pipes in the distribution network can be corroded by impurities and are hence considered here. Flame boilers and cookers are considered separately as in cookers the flame is accessible to the user, while in boilers the flame is inaccessible.

In the ISO 14687 standard, three specifications are provided for stationary PEMFC. It is unclear which situation each of the specifications applies to. For this report the most stringent specification, which applies limits similar to the vehicle PEMFC, is tentatively used. Further clarification is needed on the application of each of these three specifications.

Solid oxide fuel cells (SOFC) may also be used in micro-CHP applications. SOFC operate at higher temperatures and are more tolerant of impurities than PEMFC. However, the ISO 14687 standard does not consider SOFC. For this reason, SOFC are not included in this draft, but further discussions with partners will determine whether to include SOFC in the scope.

Boilers can also make use of the catalytic combustion of hydrogen, for lower temperature combustion than flame boilers. An example is the Giacomini CCF01-2018 hydrogen boiler [35], which requires 99.5% purity



hydrogen. This appears to be a one-off case in boiler design and so will not be considered separately, but the purity requirement is within the range studied, and so could be mapped into our structure at a later stage.

Carbon Monoxide					
CO level (ppm)	Pipes	Boilers	Cookers	Stationary PEM Fuel Cell	Vehicle PEM Fuel cell
0.2					
10				Catalyst poison	
100					
1000	15 min exposure limit				
>1000	Dangerous in single breath				

**Table 8: Impact of Impurities on End Users – Carbon Monoxide**

A conversation with a stakeholder suggested that gas engineers routinely “sniff” pipes to check if they have been purged. This presents a major health risk for carbon monoxide levels of over 1000 ppm in pipes, while 100 ppm is the 15 minute workplace carbon monoxide exposure limit. [36] A level of 200 ppm is often quoted as the 15 minute exposure limit; this limit only applies to underground mining and tunnelling industries. [36] Carbon monoxide is also a major catalyst poison for the PEMFC catalysts, and so is limited to 0.2 ppm by the ISO 14687 standard [37].

Carbon monoxide would burn in flame boilers and cookers to form carbon dioxide, which itself presents no safety risk. However, the possibility of leakage of carbon monoxide from the boiler or cooker, either during operation or maintenance, presents a safety risk. Therefore, the allowable carbon monoxide level in flame boilers and cookers is assumed here to be the same as that used for pipes.

Water					
H <sub>2</sub> O level (ppm)	Pipes	Boilers	Cookers	Stationary PEM Fuel Cell	Vehicle PEM Fuel Cell
5					
60					K <sup>+</sup> /Na <sup>+</sup> membrane harm
370	Condensation			Condensation	
> 370	Condensation and corrosion above -10 °C				

**Table 9: Impact of Impurities on End Users – Water**

Water condensing inside iron/steel pipes can cause corrosion, especially in the presence of ‘acidic’ gases like CO<sub>2</sub> which dissolve to form an acid. Oxygen will also corrode pipes in the presence of water. If water is prevented from condensing, then these issues are avoided.

The current specification for natural gas requires a dew point (the temperature at which water condenses) of -10°C, which limits water levels to approximately 60 ppm for transmission at 40 bar, 30 ppm at 80 bar and 370 ppm at 7 bar. Above these limits there is a risk of water condensing in and corroding pipes, leading to leaks and the potential for fires and explosions, and so we assume this limit here.

It is worth noting that large portions of the iron pipework (mains pipework within 30 metres of buildings) in the gas grid are due to be replaced with polyethylene pipes under the Iron Mains Replacement Programme [38]. These polyethylene pipes will be less susceptible to corrosion. However, not all mains pipework will be replaced, nor will pipework within buildings, and so the limit on levels of water applied to iron pipes will be assumed here.

In boilers, cookers and stationary fuel cells, water should not condense inside the equipment at all operating temperatures, so no further limit is assumed here.

Water itself does not have a significant impact on fuel cells, unless  $K^+$  and  $Na^+$  ions are dissolved in the water.  $K^+$  and  $Na^+$  ions contaminate the proton exchange membrane and are limited to 0.05 ppm by the ISO 14687 specification. The ISO 14687 specification therefore suggests a limit of 5 ppm for vehicle PEMFC and for water to be non-condensing at all ambient temperatures for stationary PEMFC.

Carbon Dioxide					
CO <sub>2</sub> level (ppm)	Pipes	Boilers	Cookers	Stationary PEM Fuel Cell	Vehicle PEM Fuel cell
2					
0.5 x 10 <sup>4</sup>				Hydrogen dilution	
25 x 10 <sup>4</sup>	Substantial hydrogen dilution and efficiency loss+ CO <sub>2</sub> emissions				
> 2.5 x 10 <sup>4</sup>				Conversion to CO	

**Table 10: Impact of Impurities on End Users – Carbon Dioxide**

If the water content is chosen to prevent the condensation of water, carbon dioxide does not cause a corrosion issue. High levels of CO<sub>2</sub> will have an impact by diluting the hydrogen content and the emission of large quantities of CO<sub>2</sub> into the atmosphere should be avoided due its contribution to the greenhouse effect.

The ISO 14687 fuel cell specification sets out a CO<sub>2</sub> limit of 2 ppm. However, the specification notes in Annex B that carbon dioxide does not typically affect the fuel cell function and so the effect of CO<sub>2</sub> is largely to reduce the cell efficiency due to the dilution of hydrogen. The Annex also notes that above 25 mol% CO<sub>2</sub>, carbon dioxide may be catalytically converted into CO and poison the PEMFC catalyst.

Methane					
CH <sub>4</sub> level (ppm)	Pipes	Boilers	Cookers	Stationary PEM Fuel Cell	Vehicle PEM Fuel cell
100					
1 x 10 <sup>4</sup>				Hydrogen dilution	
5 x 10 <sup>4</sup>					
> 5 x 10 <sup>4</sup>	Substantial CO <sub>2</sub> emissions				

**Table 11: Impact of Impurities on End Users – Methane**

The ISO 14687 specification notes that methane acts as an inert gas in the fuel cell and only has an impact through the dilution of hydrogen. A limit of 100 ppm is given.

For combustion uses methane will burn alongside hydrogen, but very high fractions of methane may require different burner designs. Very high levels of methane should be avoided due to the carbon dioxide formation that occurs as methane burns.

Inert gases					
Inert levels (ppm)	Pipes	Boilers	Cookers	Stationary PEM Fuel Cell	Vehicle PEM Fuel cell
300					
1000					Hydrogen dilution
> 1000	Hydrogen dilution and substantial efficiency loss				

**Table 12: Impact of Impurities on End Users – Inert gases**

Inert compounds only impact on fuel cells and combustion through the dilution of the hydrogen stream. The ISO 14687 specification limits these to 1000 ppm for stationary applications and 300 ppm for vehicle applications. Higher levels of inert gases may lead to a reduction in system efficiency and cause malfunctions in sensors and subsystems that monitor and control operation [39].

High levels of inert gases in flames may need to be accounted for in the design of the burners.

Oxygen					
Oxygen levels (ppm)	Pipes	Boilers	Cookers	Stationary PEM Fuel Cell	Vehicle PEM Fuel cell
5					
50					
$5 \times 10^4$				Degradation	
$> 5 \times 10^4$	Risk of ignition				

**Table 13: Impact of Impurities on End Users – Oxygen**

The ISO 14687 standard restricts oxygen levels to 50 ppm for stationary PEMFC and 5 ppm for vehicle PEMFC. The standard notes that low concentrations of oxygen do not adversely affect the function of the fuel cell power system, but high concentrations of oxygen cause degradation of the fuel cell.

Without the risk of water condensing and facilitating oxidation (rusting), it is not anticipated that oxygen will have a significant impact on flame cookers or boilers. Higher levels of oxygen provide a risk that if ignited, the flame may propagate.

The limiting concentration of oxygen for flame propagation of hydrogen is 5% [40], meaning that for oxygen concentrations of less than 5 % a flame will not propagate through hydrogen. This will tentatively be assumed as the safe limit for this report.

Sulphur Compounds					
Sulphur Compound levels (ppm)	Pipes	Boilers	Cookers	Stationary PEM Fuel Cell	Vehicle PEM Fuel cell
0.004					
1				Catalyst Poison	
> 1	1 ppm 15 minute exposure limit of SO <sub>2</sub>				

**Table 14: Impact of Impurities on End Users – Sulphur Compounds**

Sulphur compounds are very damaging to the catalysts in PEM fuel cells, with a limit of 0.004 ppm in the ISO 14687 stationary and vehicle fuel cell standards. When sulphur is combusted it forms sulphur dioxide, which is toxic. The 15 minute exposure limit for sulphur dioxide is 1 ppm [36].

### 3.3.3 Production & Purification Methods

This section introduces the hydrogen production and purification methods available and summarises the data that we have gathered for each of these. First, production of hydrogen from fossil fuels is examined, followed by electrolysis and by-product production of hydrogen.

Methods for producing hydrogen from fossil fuels first involve the production of syngas, which is a mixture of hydrogen, carbon dioxide, carbon monoxide and sometimes unreacted methane and water. In order to use hydrogen for heating applications it needs to be separated from this mixture. The technologies available to do this are discussed in this report. It should also be noted that in order to produce low carbon hydrogen from fossil fuels, the carbon dioxide produced in the syngas must be captured.

Given that the subject of this study, as part of Hy4heat WP2, is hydrogen purity, we focus on the aspects of the hydrogen production most relevant to the purity of the gas produced. For a broader discussion of hydrogen production, we have found the following references useful:

- The Leeds H21 North of England report [21] provides an in depth analysis of production methods available for large scale hydrogen production. The report models 1.5 GW production plants to calculate their efficiencies, costs, CO<sub>2</sub> footprint, site footprints and energy usage. Proton exchange membrane (PEM) and alkaline (AEL) electrolysis, steam methane reforming and autothermal reforming, coal gasification and ammonia as a transport medium are all considered in this report.
- Volsund et. al [31] and the IEAGHG technical review [41] offer overviews of hydrogen production through syngas. These reports study Steam Methane Reforming (SMR), Autothermal Reforming ATR, Partial Oxidation (POx) and gasification methods, including typical example syngas compositions and purification methods available. Voldsund et al. also provide a review of the methods available for purifying hydrogen produced via syngas.
- Buttler et. al [42] provides an overview of electrolytic routes to hydrogen production.
- Sgurr energy [43] and the Roads2HyCom project [44] studied hydrogen infrastructure in the UK, and summarise by-product hydrogen production routes.

#### 3.3.3.1 Syngas Production

There are several standardised steps used in syngas production. These steps are outlined below. Further information on the water gas shift reaction is given in Section 0, including a summary of the literature data on the molar fractions of carbon monoxide reached by the reaction.

The first step is the pre-treatment of the hydrocarbon input in order to avoid the poisoning of downstream catalysts. The IEAGHG technical review [21], Ritter et. al. [25] and the H21 report [21] outline these steps. Chloride compounds and sulphur are poisonous to the catalyst used in the reformation reaction (the reaction used to produce syngas) and so are removed by hydrogenation and de-sulphurisation. An EMPIR study of hydrogen contaminants [23] notes that all sulphur species react to form H<sub>2</sub>S in the hydrogenation step and then H<sub>2</sub>S is reduced to less than 50 nmol/mol by design and less than 10 nmol/mol in practice.

For heavy hydrocarbon feedstock, pre-reforming is sometimes used to convert heavier hydrocarbons in hydrogen and carbon oxides.

Post-reformation or gasification (the reaction which produces syngas from liquid/solid feedstock), a water gas shift (WGS) reaction is used to remove carbon monoxide and produce further hydrogen.

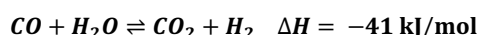

Standard condensation processes are then used to remove excess water from the hydrogen production [25] and any further purification steps follow. A simplified schematic of these steps is shown in Figure 3.

The exact stage in the process where water is condensed out depends upon the purification step used. Carbon can be captured at different stages in the process, dependent upon the production and purification methods used, so the points for carbon capture are not shown in Figure 3 but are discussed in the overview of the production technology.

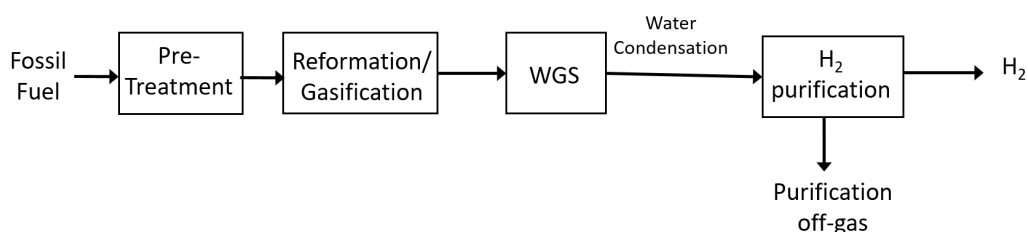

**Figure 3: An overview of the steps for hydrogen production from syngas**

A discussion with a stakeholder indicated that the molar fraction of water will be 0.3-0.4% post cooling and condensing to 40°C at 25 bar pressure and a study by the AMEC Foster Wheeler modelled a 0.24% molar fraction of water post-condensation. A discussion with a stakeholder also noted that an active filter can be used to reach lower levels if required.

Data sampled by the Dynamis project and used in [45] found the water levels to be < 250 ppm for both a steam methane reformer and autothermal reformer post carbon capture. The methods used to reach these water contents however are not specified.

### 3.3.3.2 Steam Methane Reformation

Steam Methane Reformation (SMR) is widely used for producing hydrogen from natural gas, producing 48% of hydrogen worldwide [46]. In the reaction chamber natural gas is reacted with steam to produce carbon monoxide and water, the reaction is shown below:

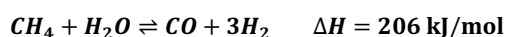

This is an endothermic reaction, which requires steam and according to Voldsund et. al is undertaken at temperatures in the range 500-900°C and pressures of 20-35 atm with a Nickel catalyst. [31] Heat for the reaction is provided by burning natural gas or the off-gas produced by a Pressure Swing Adsorber (PSA) if used for purification. A schematic of the reaction chamber for one reformer design is shown in Figure 4.

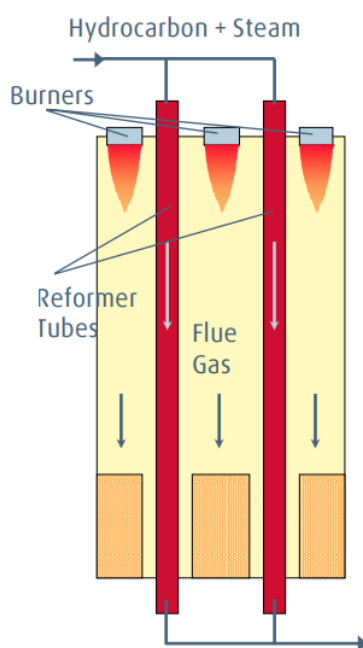

**Figure 4: Diagram of an SMR [47]**

Example syngas compositions produced by SMRs are summarised in Table 15. The exact composition of the syngas will depend upon the reaction conditions. Higher conversions of methane to hydrogen are favoured by high temperatures, low pressure and a high steam-to-carbon ratio (S/C ratio). However, high temperatures and high S/C ratios reduce the energy efficiency of the process.

Molecules	Fraction of SMR syngas (dry mol %)
H <sub>2</sub>	63-66
CO	8-16
CO <sub>2</sub>	7-14
CH <sub>4</sub>	3-8
N <sub>2</sub>	0-3
Sources	[49], [25], [48], [24]

**Table 15: Literature values for SMR syngas compositions**

### Carbon Capture Options

Carbon dioxide is produced at two points in a SMR: CO<sub>2</sub> is produced at low pressure by the burner that heats the reformer and at high pressure by the reformation reaction itself. CO<sub>2</sub> can hence be captured from the flue gas produced by the burner at low pressure and from the syngas at the output of the reformer at high pressure.

## Impurities Data

The EMPiR Project [23] analysed the impurities that may be expected to be produced by an SMR. On top of the carbon dioxide and carbon monoxide found in the syngas, the report anticipates that nitrogen, argon, hydrocarbons, water, formic acid, ammonia and formaldehyde may be found.

The report anticipates that nitrogen, argon, and hydrocarbons (with more than two carbons) are present in natural gas, and so are expected to be found. Both sulphur and halogenated compounds are also found in natural gas but are removed in the feedstock pre-treatment. Helium may also be found in natural gas but is not found in European natural gas ( $\text{He} < 10 \mu\text{mol/mol}$  in Europe). Water is also expected to be found, while formic acid, ammonia and formaldehyde may form in the reformation chamber, and so may also be found at the mmol/mol level. Oxygen is not found in the reactants and is noted to be unstable under the SMR reaction conditions. Oxygen is therefore not anticipated to be found.

The report also notes that pre-treatment for SMR is designed to reduce  $\text{H}_2\text{S}$  to less than 50 nmol/mol by design and reaches less than 10 nmol/mol in practice. The pipes and vessels in the production process are also noted to act as a barrier to sulphur impurities, as sulphur compounds have a strong affinity with steel.

A discussion with a stakeholder confirmed that formic acid and formaldehyde are found in syngas at low levels, but both are soluble in water and so will be removed in the process condensate and by the  $\text{CO}_2$  wash unit used for carbon capture. Ammonia on the other hand is not found at a significant level. It was also noted that if the syngas is cooled to  $40^\circ\text{C}$  at 25 bar pressure, the molar fraction of water will be 0.3-0.4%.

## Cost Data

The H21 NoE report [21] modelled the cost of a 1.5 GW SMR that captures  $\text{CO}_2$  from both the burner flue gas and the syngas, capturing 91.2% of the  $\text{CO}_2$  produced. The report predicts a natural gas consumption of 1850 MW and an electricity import of 35.6 MW, leading to an overall efficiency of 79.5% HHV. The capital cost for the plant is estimated to be £1,100 million or £0.7 million per MW.

The IEA [24] undertook a techno-economic evaluation of a 100,000  $\text{Nm}^3/\text{h}$  (300 MW LHV) SMR plant using a PSA for purification, and considered the costs of several carbon capture methods. The base case of SMR without a PSA carried a capital cost of €223 million (£200 million using today's exchange rate) or £0.7 million per MW. This amounts to a levelized cost of hydrogen of €0.114 per  $\text{Nm}^3$ . The case with high pressure capture from the shifted syngas carried a capital cost of €299 million, or £0.9 million per MW.

### 3.3.3.3 Autothermal Reformation

An Auto-Thermal Reformer (ATR) consists of two reactions. The first step is the partial oxidation of methane in an exothermic reaction, shown below.

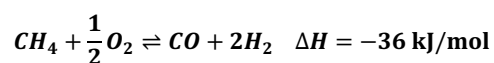

This step then provides heat for the next step, which is the same reaction as takes place in a SMR, shown below.

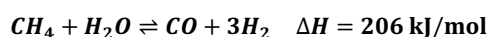

An overall equation for the reaction is shown below:

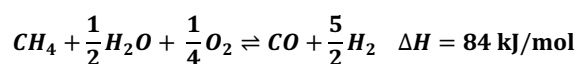

A schematic of an ATR reaction chamber is shown in 16.

Example reaction conditions found by the IEAGHG technical review [41] are 950-1050 °C and 30-50 bar pressure. The higher reaction temperature means that ATRs can achieve higher methane conversions than SMRs. The partial oxidation step produces more CO per mole of hydrogen than the steam methane reformation step, and so the syngas produced by an ATR usually has a higher ratio of carbon monoxide to hydrogen than that from an SMR. [41]

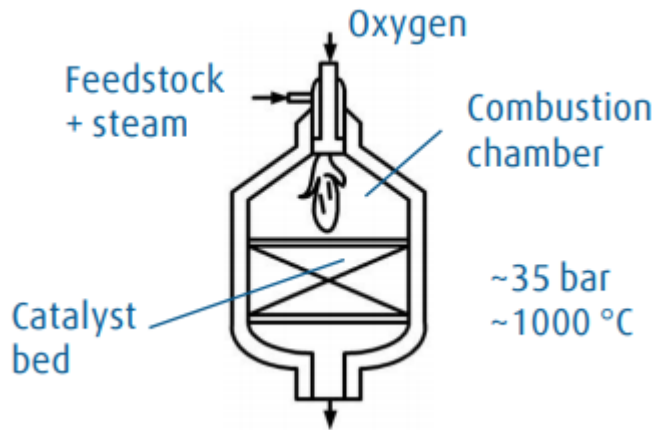

**Figure 5: A diagram of an ATR reaction chamber [47]**

An ATR requires an oxygen feed for the partial oxidation step. This can be provided by producing purified oxygen using an air separation unit, as the H21 project [21] suggests, or can use an air feed. Using an air feed leads to higher levels of nitrogen and other inert gases being present in the syngas. An air separation unit is expensive and so sometimes a pre-reformer is used to reduce the oxygen requirement of the ATR.

A discussion with a stakeholder noted that no large scale 100% air blown ATR is in operation today. In the case of an air blown ATR with a PSA, they noted that the off-gas of the PSA may not combust due to the high inert gas content. Example syngas compositions produced by oxygen and air fed ATRs are summarised in Table 16.

Molecules / Species	Oxygen-Fed ATR (dry mol %)	Air-Fed ATR (dry mol %)
H <sub>2</sub>	63-66	35-60
CO	27-30	13
CO <sub>2</sub>	5-6	8-10
CH <sub>4</sub>	0.3-1.4	0.4
N <sub>2</sub>	0.7 *	21-41
Ar	0.61	0.39-0.45 **
Sources	[25],[41],[45]	[49], [50]

**Table 16: Literature values for ATR syngas compositions**

\* These values are for a syngas after carbon capture, used as indicative values.

\*\* These values are for a syngas after the water gas shift reaction.



## Carbon Capture

The ATR is heated by the POx reaction and so a separate burner is not required to provide heat for the reformer. This means that almost all the CO<sub>2</sub> is produced in the reformer and so can be captured from the syngas. Note that some gas may still be burnt to provide steam for the reaction and sometimes to pre-heat the reformer feed.

## Impurities data

Perhaps due to the relative immaturity of ATR technology compared to SMRs, there is little information in the literature on the impurities found in hydrogen produced via ATR, including in the EMPIR or HyCORA project. However, the reactants, products and reaction conditions in an ATR are very similar to those in an SMR, and so we anticipate many of the results on impurity levels via SMR also apply to ATR. However, for an oxygen blown ATR we would expect to find higher levels of argon than for an SMR, as the air separation unit does not effectively remove argon [45].

For air blown ATR higher levels of nitrogen are also expected. Oxygen is now also present in the reactants, but, as in the case of the SMR, oxygen is unstable under the reaction conditions and so is expected to be used up in the reaction. Argonne National Laboratory [51] studied catalysts for the autothermal reforming of gasoline, and found no oxygen in the product gas. It is assumed that this will also be the case for a gas-fed ATR.

As discussed in the previous section, the syngas of an ATR has a higher fraction of CO than an SMR. However, discussion with a stakeholder suggested that after the WGS step, SMR and ATR produced hydrogen would have similar levels of carbon monoxide. The IEAGHG technical review [41] supports this, stating that for an ATR to meet a similar CO slip to an SMR, additional steam is needed for the shift reaction.

## Cost Data

The H21 NoE report [21] estimates the capital cost of a 1.5 GW ATR plant, running alongside a GHR, with carbon capture from the syngas to be £947 million, or £0.6 million per MW. The plant is predicted to import 72.6 MW of electricity and use 1,805 MW of natural gas, giving an overall efficiency of 79.9% HHV and hydrogen cost of £50 / MWh.

### 3.3.3.4 Gas-heated Reformation

A Gas Heated Reformer (GHR) works alongside an ATR or SMR. The excess heat from the ATR or SMR is used by a gas heated reformer to drive the reforming reaction. Johnson Matthey license GHRs that partially reform their ATR feed streams, as part of their DAVYTM reforming technologies [52].

Haldor Topsoe produce a similar technology, called a Haldor Topsoe Exchange Reformer (HTER), which operates in parallel with another reformer. In 2007, Haldor Topsoe licensed more than 25 HTERs to existing SMR or ATR plants, adding extra capacities of 100-10,000 Nm<sup>3</sup>/h [53].

Given that GHR technology is essentially the addition of an extra reformer to an SMR or ATR, the syngas composition and the impurities present will be a mixture of those found in an SMR and ATR. Hence, we do not suggest considering GHR as a separate case in this report.

### 3.3.3.5 Partial Oxidation

Partial oxidation (POx) is used for hydrogen production from low quality feedstock such as diesel, residual oil, coal, petroleum and coke. [31] The reaction is the first step of the ATR process:

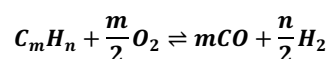

Data from the IEAGHG technical report [41] suggests that ATR has a higher thermal efficiency than POx for natural gas reforming, with an ATR consuming 364 MW natural gas for 300 MW of hydrogen and POx requiring 450-540 MW feedstock for 300 MW (all figures in an LHV basis).

### 3.3.3.6 Coal Gasification

Gasification is used to produce syngas from solid feedstock such as coal or biomass. The POx reaction is one of the reactions that occurs in the gasification of feedstock. Two other endothermic reactions occur that generate hydrogen, as shown below. Further reactions producing carbon monoxide and carbon dioxide also occur.

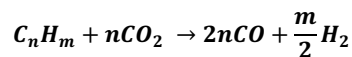
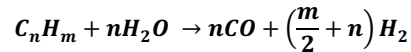

An example gasifier, using technology produced by Shell, uses pressures of 20-40 bar and temperatures of 1440-1600°C [31].

The H21 report [21] modelled the different production methods at for a plant capable of producing 1.5 GW hydrogen. The results of this modelling are shown in Table 17.

	ATR	SMR	ELECTROLYSIS	GASIFICATION	NH <sub>3</sub> CRACKING
Energy Efficiency (%-HHV)	79.9	79.5	70.9	55.3	87.5-88.9
CO <sub>2</sub> footprint	13.1	20.5	0	60.3	0
Specific cost (£/kW <sub>18%112</sub> )	631	721	1,160	1,691	235-248
Area (ha/GW)	10-15	25-30	30-40	40-70	8-10

**Table 17: Modelled data of 1.5 GW production plants. [21]**

### 3.3.3.7 Biomass/Waste Gasification

Hydrogen can be produced from biomass or waste using gasification processes and is a process that can produce negative emissions if combined with carbon capture. The production of hydrogen from waste has been demonstrated on a pilot 50 kW scale by the Biohydrogen project [26]

The BIONICO FCHJU project [54] is also investigating hydrogen produced by the reformation of biogas, using a membrane reactor. The syngas produced by the Biohydrogen project is shown in Table 18.

Molecules	Fraction of SMR syngas (dry mol %)
H <sub>2</sub>	32
CO	32
CO <sub>2</sub>	29
CH <sub>4</sub>	3
N <sub>2</sub>	4

**Table 18: Syngas produced in the Biohydrogen project [26]**

## Impurities Data

A discussion with a stakeholder suggested that higher order alkanes, higher order alkenes and NO<sub>x</sub> are all anticipated to arise from the gasification process, and cyanide and heavy metals will arise specifically from the gasification of waste. However, the stakeholder confirmed that most of these impurities should be reduced to low levels before any catalytic reformation.

## Cost Data

The cost of hydrogen produced by the Biohydrogen project was £25/MWh without CCS or £42/MWh with CCS.

### 3.3.3.8 Water Gas Shift

Reformation methods produce a mixture of carbon monoxide and hydrogen, and so a water gas shift (WGS) reaction is used to produce carbon dioxide and hydrogen from carbon monoxide and steam. The WGS reaction is shown below.

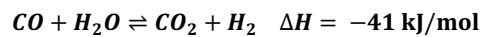

This is an exothermic reaction, and so the products are favoured by low temperature, which is to the detriment of the reaction rate.

WGS is often undertaken in two stages, a high temperature shift (HTS) for a faster reaction rate, and a low temperature shift (LTS) to push the equilibrium further towards the products. Example temperatures for these HTS and LTS are 315-450°C and 190-250°C for respectively [25], [49]. The WGS reaction is a reversible reaction, and so the exact composition of the product is dependent upon the reaction conditions and the composition of the input syngas.

Mendes et. al. [49] give Equation 1 and Equation 2 (as below) for determining the equilibrium product of a WGS reaction. Equation 1 can be used to calculate the equilibrium constant for a WGS reaction at a given temperature and Equation 2 can be used to determine the equilibrium CO conversion given the molar fractions of species in the syngas. In Equation 2,  $y_i$  is the molar fraction of species  $i$  in the inlet and  $x$  is the equilibrium CO conversion.

$$\text{Equation 1: } K_p = \exp\left(\frac{4577.8}{T} - 4.33\right)$$

$$\text{Equation 2: } K_p = \frac{(y_{CO_2} + y_{CO}X)(y_{H_2} + y_{CO}X)}{[y_{CO}(1-X)](y_{H_2O} - y_{CO}X)}$$

Literature data on the syngas compositions after the WGS for different reformers are summarised in Table 19. The data shows that carbon monoxide levels of 0.2 mol% and 0.1 mol% are achievable for an oxygen blown ATR and a SMR respectively. This observation is consistent with the suggestion by a stakeholder that an SMR and ATR can be designed to have similar levels of carbon monoxide after the WGS step.

Molecules / Species	SMR (dry mol%)	Oxygen-Fed ATR (dry mol %)	Air-Fed ATR (dry mol %)
H <sub>2</sub>	70-80	72	44-62
CO	0.1-3	0.2-1.4	0.5-0.6
CO <sub>2</sub>	15-25	27	17-18
CH <sub>4</sub>	3-6	0.2-2.4	0.07-0.3
N <sub>2</sub>	0-0.2	0.7 *	19-38
Ar	0	0.61	0.39-0.45
Sources	[31],[25],[45]	[41] [55]	[31], [49]

**Table 19: Literature values for syngas compositions after the water gas shift reaction.**

\* These values are taken from a syngas composition after carbon capture.

The composition of the oxygen fed ATR is consistent with a calculated syngas composition based upon the values in Table 19. The composition was calculated using the chemistry of WGS reaction and assuming that the WGS reduces CO to 0.2 mol%.

### 3.3.3.9 Syngas Purification

The options for separating hydrogen from syngas include:

- pressure swing adsorption (PSA)
- membrane-based purification;
- absorption based purification;
- cryogenic purification;
- electrochemical purification.

### 3.3.3.10 Pressure Swing Adsorption

Pressure swing adsorption (PSA) is currently the industrial standard to purify hydrogen produced by the reformation of natural gas.

According to Sircar et al. [48] the feed gas compositions PSA processes can have between 80 and 93% hydrogen recovery rate, dependent upon the conditions used, and produce 98-99.9999 mol% hydrogen. A conversation with a stakeholder suggested that PSAs can have 85-90% hydrogen recovery rate, while another stakeholder suggested that higher recoveries can be reached with more columns.

Linde [56] give a full explanation of the steps involved in purification by PSA. In simplified terms, syngas is passed at high pressure through beds filled with adsorbing material, onto which the impurities adsorb. The pressure is then reduced so that the impurities desorb, and some of the hydrogen product is used to purge the chamber before it is re-pressurized for another adsorbing cycle. In order to allow a semi-continuous flow of hydrogen, at least four chambers are required, but industrial processes typically use more to increase recovery rates.

The 'unrecovered' hydrogen in the off-gas can be recycled to the burner to provide heat for the reactor in an SMR and to pre-heat the feed and produce steam for an ATR, and so replaces some of the natural gas fuel required. The PSA is usually pressurized using the pressure from the reformer and produces hydrogen at near-feed gas partial pressure.

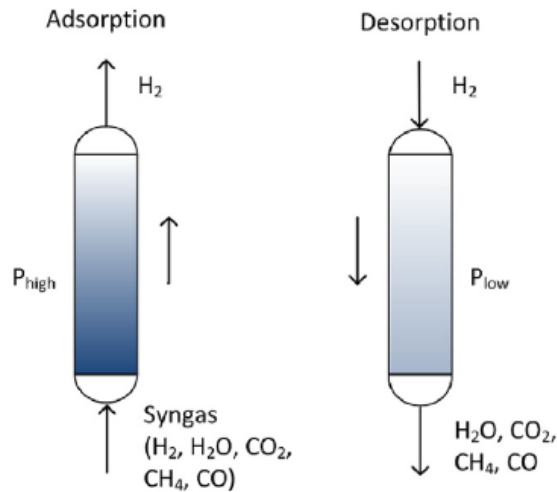

**Figure 6: A depiction of the adsorption and desorption steps for a PSA bed, the bed is filled with adsorbent granules, pure hydrogen product flows out of the top of the bed, and the impure off-gas out of the bottom.**

Typical adsorbing materials are zeolite 5A, silica gel, alumina, activated carbon. For these material different impurities adsorb at different rates. A qualitative ranking of the adsorption forces for a typical Linde PSA is shown in Figure 7. If more of impurities that are weakly adsorbing, such as nitrogen and carbon monoxide, need to be removed more hydrogen will adsorb and hence the hydrogen recovery rate is lowered.

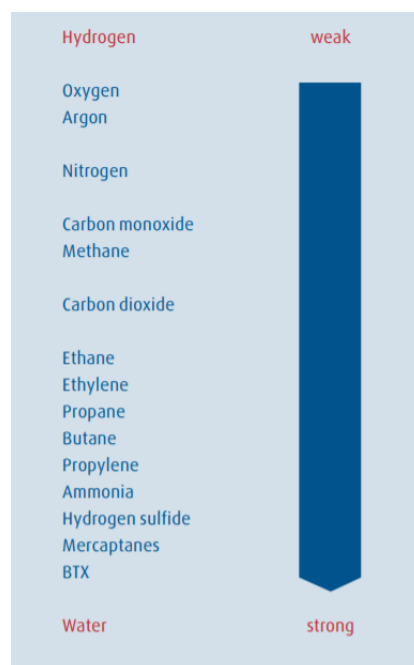

**Figure 7: Relative strengths of adsorption to a Linde PSA material [56]**



The purity of hydrogen can be increased by both adsorbing more impurities onto the adsorbent material and removing more impurities from the adsorbent during the purge step, both of which decrease the hydrogen recovery rate.

A discussion with a stakeholder reported that increasing feed pressures (fixed by the reaction), decreasing feed flow rate and increasing the amount of adsorbing material (although this is often fixed by a standard bed size) can be used to vary the amount adsorbed during the adsorbing step, while purge flow rate and desorbing pressure change the amount of impurities purged from the chamber.

### **Impurities Data**

The HyCORA project studied the contaminants found in hydrogen sampled at hydrogen refuelling stations, including eight samples for hydrogen produced by an SMR and transported to refuelling stations [57], [58]. Two of the samples did not meet the ISO 14687-2 standard for fuel cell vehicles and these had slightly higher oxygen levels than was allowable of 6 ppm and 11 ppm.

The EMPIR project also analysed impurities found in 5 hydrogen samples produced by an SMR and purified with a PSA. All of these samples met the ISO 14687-2 standard, with oxygen levels of less than 0.5 ppm.

These results demonstrate that a PSA can effectively remove the impurities found in SMR produced hydrogen in order to meet the most stringent standard that we consider in this report.

### **Cost Data**

The capital cost of the PSA is determined by the number of PSA beds used, the amount of adsorbent in each bed (related to the size of the bed), and the number of switch valves required. The H21 project [21] determined a total project cost of £122 million for a PSA that purifies 313,000 Nm<sup>3</sup>/hr of impure hydrogen, to produce 282,000 Nm<sup>3</sup>/hr of pure hydrogen (1 GW). A discussion with a stakeholder suggested that the cost of an industrial PSA is estimated to be in the "high single digit figures" as a percentage of the total plant cost.

A stakeholder obtained a quote for a PSA producing 1 tonne/hour (33 MW) of hydrogen at 99.99% purity. This was found to comprise a capital and design cost of £5 million and an installation cost of £0.1 million. The operating costs are assumed to be negligible in comparison.

The operating costs of the PSA are low, as the pressure is driven by the reformation pressure. The key cost is therefore the ~10% loss of hydrogen product during the purge step. The impact that this has on the overall efficiency of hydrogen production is unclear. The H21 report [21] models a 10% lower efficiency for between an SMR with a PSA compared to an SMR without a PSA, while another stakeholder noted that a flow scheme with methanation and a flow scheme with PSA have the approximately the same efficiency. These differences will be clarified in further discussions with stakeholders.

Sircar et. al estimate that a 2% variation in recovery for a 35,000 Nm<sup>3</sup>/h plant could give a revenue difference of \$9.5 million over a 15 year lifetime, equal to about ~150% of the PSA plant cost [48].

### **Hydrogen Recovery Rate Data**

Air Liquide and SINTEF modelled the variation of impurity concentration with hydrogen yield [45] by varying the adsorbent volume for syngas produced by SMR, ATR and coal gasification. The results that they found for the SMR are shown in Figure 8 and for an ATR in Figure 9.

The syngas used for the SMR in Figure 8 comprised 94.3% H<sub>2</sub>, 0.1% CO, 2.5% CO<sub>2</sub>, 0.2% O<sub>2</sub> and 2.9% CH<sub>4</sub>. The syngas used for the ATR in Figure 9 comprised 93.2% H<sub>2</sub>, 1.4% CO, 1.7% CO<sub>2</sub>, 0.7% N<sub>2</sub>, 0.6% Ar and 2.4% CH<sub>4</sub>.

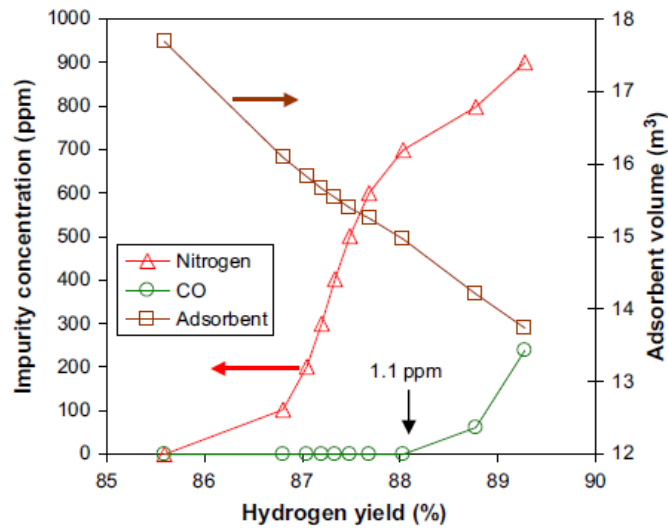

**Figure 8: Modelled variation of impurity concentration with hydrogen yield for an SMR [45]**

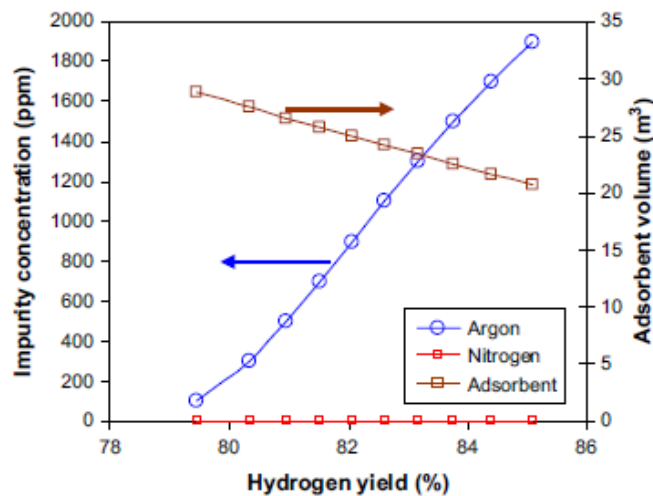
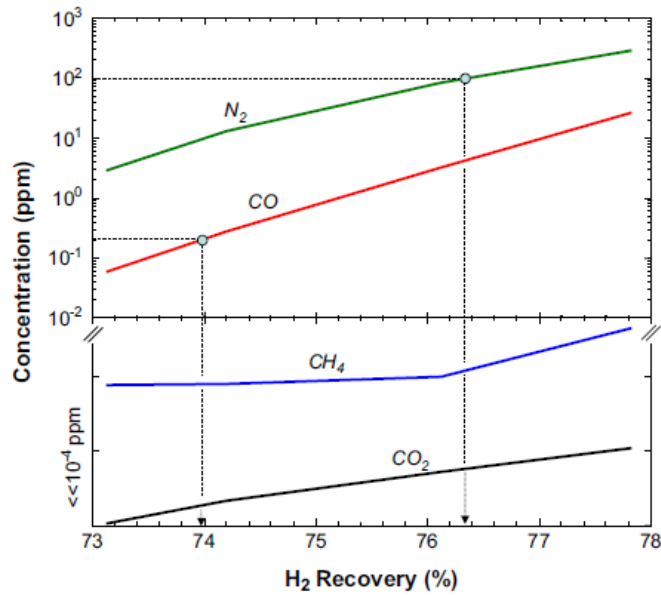

**Figure 9: Modelled variation of impurity concentration with hydrogen yield for an ATR [45]**

The data in Figure 9 is modelled with reference to the ISO standard. For the case of oxygen-blown ATR, argon was found to be the limiting impurity in meeting this standard and so carbon monoxide is not included in the chart.

The US Department of Energy [39] modelled the variation of recovery rates of hydrogen for carbon monoxide levels between 0.1 and 10 ppm and for a small 1500 kg/day SMR-WGS-PSA system. Due to the small scale of the production system, which was targeted at production in the forecourt of a refuelling system, they modelled a four bed PSA system. This will give lower recovery rates than larger scale production, which use 10-12 beds to increase the recovery rate.

The report models the variation in recovery rate with concentration of impurities by varying process parameters such as the steam to carbon (S/C) and pressure, which also affect the SMR reaction as well, and the composition of the adsorbing beds. The results of the models are shown in Figure 10:



**Figure 10: Modelled variations in impurity concentrations with H<sub>2</sub> recovery for 1500kg/day SMR [39]**

The effect on hydrogen production cost of impurity levels was examined through the variation in the overall process efficiency, assuming the capital cost and operating costs involved with changing the parameters to be negligible. They found that the cost of hydrogen varied by at most \$0.05 / kg H<sub>2</sub> for an order of magnitude change in carbon monoxide level.

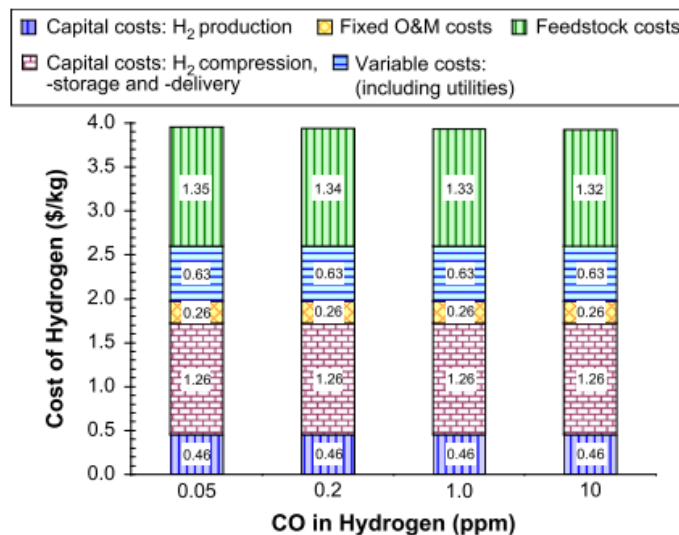

**Figure 11: Cost components of hydrogen refuelling station as function of CO concentration [39]**

Discussion with a stakeholder estimated that if the purity of hydrogen required were reduced below 99.99%, then the hydrogen recovery rate would only be improved by a few percentage points. This suggests that a significant cost – in the form of unrecovered hydrogen – is an unavoidable consequence of using a PSA regardless of the purity targeted.



## Potential Innovations

Fast cycle PSA has been produced on the scale of 1,000 Nm<sup>3</sup>/h at reduced capital cost and equipment footprint. This has been demonstrated to operate at a hydrogen recovery of 80%, which is deemed too low for our current purposes. [28] There are also some designs of PSA that can produce pure streams of both hydrogen and carbon dioxide for carbon capture. A PSA expert at the University of Edinburgh suggested that there is also work at the research level investigating the use of metal organic frameworks as an adsorbent material.

### 3.3.3.11 Absorption

Separation by absorption is carried out by bringing the syngas into contact with a liquid solvent that absorb impurities, typically carbon dioxide. The solvent is then regenerated, by releasing CO<sub>2</sub>, at raised temperature or reduced pressure. The CO<sub>2</sub> can then be directly dried and compressed for carbon capture and storage CCS. Amine based methods were used to purify hydrogen commercially before PSA was commercialised. [31] For any hydrogen purity level in the range of our interest, chemical absorption of CO<sub>2</sub> will be required at some point in the production process.

Typical chemical solvents, which react with carbon dioxide, are amine solutions such as MEA (monoethanolamine), TEA (triethylamine), MDEA (N-methyl-diethanolamine), PZ (piperazine) or potassium carbonate. The current state of the art technology is activated MDEA (aMDEA) where MDEA is activated by PZ. Shell's ADIP-X technology makes use of aMDEA [59] [60]. The H21 NoE project recommends using aMDEA for the high-pressure CO<sub>2</sub> capture. An example CO<sub>2</sub> wash unit examined by Linde [22] for capturing CO<sub>2</sub> from an SMR syngas captures 98% of the CO<sub>2</sub> present in the syngas.

An alternative to chemical solvents are physical solvents, which dissolve CO<sub>2</sub> rather than reacting with it. Physical solvents typically require less energy for regeneration than chemical solvents [41]. Examples are Rectisol, Selexol and Purisol. The exact choice of solvent depends upon the operating conditions; more active solvents are needed for low pressure CO<sub>2</sub> removal, which require more heat to be regenerated.

Discussion with a stakeholder reported that they would not usually recommend Rectisol for the separation of carbon dioxide from syngas produced by an SMR or an ATR. Instead, MDEA would be recommended, due to the higher costs in the extra equipment needed for Rectisol. Rectisol would only be recommended for the gasification-produced syngases in which more impurities need to be removed.

## Cost Data

Data on cost of carbon capture using amine-based methods, described in this section, is summarised in Table 20-.

	Tomokai	Shell Quest	IEA SMR CCS Study	Linde CCS Study
Carbon Captured (t/h)	25.3	150	46.6	46
Hydrogen Production Rate (kNm <sup>3</sup> /h)	67	416	100	100
Import Power (kWh/t CO <sub>2</sub> )	19 *	140	77	96
LP Steam Feed (t steam/t CO <sub>2</sub> )	0.41	0.42	1.38	1.09
Additional Cost of hydrogen production	n/a	n/a	0.007 €/kWh H <sub>2</sub>	0.009 €/kWh H <sub>2</sub>

**Table 20: Literature data on CO<sub>2</sub> capture from syngas using amine based methods**

\*This power is only for the amine pumps and does not include CO<sub>2</sub> compression.

Advanced Plasma Power (APP) use potassium carbonate in the Benfield process, with an amine activator, to remove and capture CO<sub>2</sub> produced by their BioSNG plant. This has an input of 1,200 kg/h gas that is 50% CO<sub>2</sub>, 22% H<sub>2</sub>O, 28% CH<sub>4</sub> by volume. The CO<sub>2</sub> scrubber cost is £0.6m and has negligible operating costs, as waste heat is used to regenerate the solvent. Discussion with a stakeholder at APP suggested that the choice of solvent was based on the solvent regeneration heat matching well with the waste heat available in the process.

A Linde CCS comparison [22] examined the cost of an amine based CO<sub>2</sub> wash unit for CO<sub>2</sub> capture from the syngas of a SMR. The study finds a total CO<sub>2</sub> capture cost of €39 per tonne CO<sub>2</sub> when the costs of power (50 €/MWh) and steam (25 €/tonne) are included.

In an IEA study of carbon capture from a 100,000 Nm<sup>3</sup>/hr SMR [24], the costs of CO<sub>2</sub> capture from the syngas using MDEA are modelled. The total cost of CO<sub>2</sub> avoidance is found to be 46 €/tonne CO<sub>2</sub> or an additional €0.021 per Nm<sup>3</sup> H<sub>2</sub> on top of the base cost of € 0.114 per Nm<sup>3</sup> (0.038 €/kWh) without CO<sub>2</sub> capture.

The CO<sub>2</sub> capture plant captures 0.466 tonnes CO<sub>2</sub> per 1000 Nm<sup>3</sup> H<sub>2</sub> and uses 0.57 MW of electricity and 64.4 tonnes per hour of low-pressure steam (0.34 MPa, 177 °C) and the CO<sub>2</sub> compression and drying unit uses 3 MW electricity. The total capital costs for the CO<sub>2</sub> capture and CO<sub>2</sub> compression units are €22 million and €17 million respectively, amounting to 11% and 8% of the total plant cost.

An IEAGHG technical review [41] summarises data on the operating expenses of CO<sub>2</sub> capture in demonstration hydrogen production plants. The Tomokai project in Japan captures 99.9% of the CO<sub>2</sub> produced at a rate of 25.3 tonnes CO<sub>2</sub> per hour. The CO<sub>2</sub> capture plant imports 0.49 MW for the amine pumps (not including CO<sub>2</sub> compression) and 10.4 tonnes per hour low pressure steam. The Shell Quest Project in Canada captures CO<sub>2</sub> from three SMRs, with a combined hydrogen production capacity of 37.4 tonnes H<sub>2</sub> per hour. The CO<sub>2</sub> capture plant uses 21 MW electrical power and 63 tonnes per hour of low-pressure steam for solvent regeneration.

## Hydrogen Recovery Rate

Only CO<sub>2</sub> and a few select components (for example other acidic gas components) are removed by chemical absorption, and there is no loss of hydrogen. The remaining impurities found in the hydrogen will match those found in the syngas.

### 3.3.3.12 Membranes

Membranes that are selectively permeable to hydrogen can separate hydrogen from mixtures of gases. Pressure on the process side of the membrane drives the diffusion of hydrogen across the membrane, which is separated at low pressure on the other side of the membrane. [31] A depiction of the membrane function is shown in Figure 12.

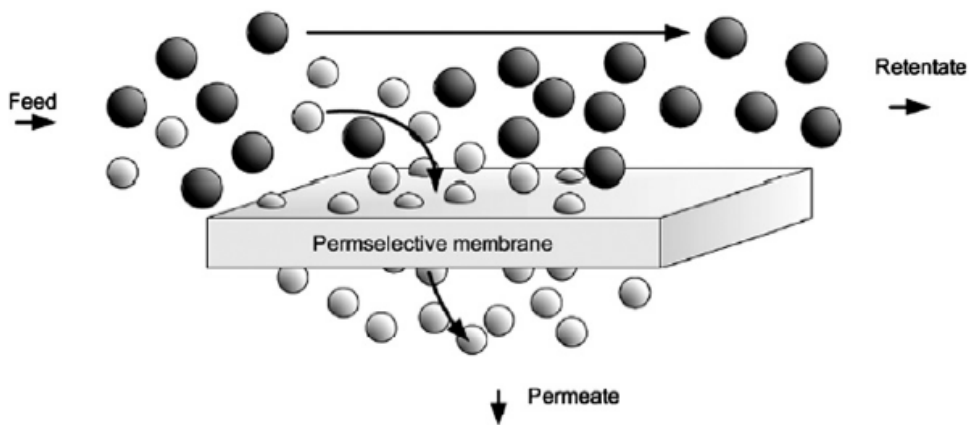

**Figure 12: Membrane purification of hydrogen from syngas [61]**

Gallucci et al. [61] provide an overview of the different types of membranes that can be used to separate hydrogen. Membranes are categorised into polymeric, microporous ceramic, porous carbon, dense metallic (palladium based) and proton conducting dense ceramic membranes. In this report we will consider polymer and Pd-based membranes, as they are commercially available or have been trialled at a pilot scale.

### 3.3.3.13 Pd-Based Membranes

There are two forms of Pd-based membranes, pure Pd-membranes and supported Pd-based membranes. Pure Pd-membranes are commercially available for the production of very high purity hydrogen and are often used in the electronics industry. For example, SAES produce a purifier to "9 nines" purity (99.999999%) in the PS7-PD2 membrane [62]. These are costly and have low hydrogen fluxes due to the membrane thickness. [61] Hence, we do not propose considering these membranes for large scale hydrogen purification.

Supported Pd-based membranes use a thin layer of palladium to reduce the capital cost and increase the hydrogen flux. These are in pre-commercial stage, with a few projects demonstrating their production and use. [63], [64], [65] A thinner membrane leads to more defects in the Pd-membrane, which decreases the output purity [66]. Tokyo Gas, for example, achieved 99.99% output purity. [63]

Membranes can also be integrated into hydrogen production. Hydrogen production is equilibrium-limited, and so if hydrogen is continuously removed from the reaction, the reaction will shift to favour the production of hydrogen. This can be applied to the reformation reaction or the WGS reaction.

Tokyo Gas [63] have trialled a membrane reactor producing 40 Nm<sup>3</sup>/h, which achieved an efficiency of 81.4% HHV at 99.99% purity for over 8000 h, and an efficiency of 78.6% if carbon dioxide is captured (capturing

50%) by liquefaction. The FERRET project [67] used a Pd-based membrane reactor to produce hydrogen at rates of around 3.4 Nm<sup>3</sup>/h with a total production efficiency of 88% HHV.

### Purity information and problem impurities

In theory, Pd-based membranes should produce 100% pure hydrogen as only hydrogen can pass through. However, with thinner membranes pin-hole defects are formed which impurities can pass through. This means that the impurities that will pass through the membrane will match the impurities in the syngas.

The membranes are poisoned by sulphur species, while carbon monoxide can reduce the flux through the membrane at temperatures below 250°C. [66] There has been work done in alloying Pd-based membranes to reduce the impact of impurities.

### Technology Readiness

A conversation with a stakeholder estimated the technology readiness level (TRL) to be 5-6.

Fernandez et al. [65] have worked in the production of membrane reactors for various processes, and note that the long term stability of the Pd-based membrane needs to be improved before Pd-based membranes can become commercially available. Carbon monoxide levels for a membrane-enhanced WGS reaction were tested, reaching CO content below 10 ppm. However, hydrogen recovery factors of around 50% were found.

The Tokyo Gas trial (see above) has demonstrated on a small scale the production of hydrogen to high purity, and at efficiencies close to those proposed in the H21 report (where no purification step is undertaken). If membranes such as this became commercially available, they could likely be used to meet high purity specifications without having to make a trade-off in efficiency.

### Cost Data

The FERRET project [68] estimated the costs of producing Pd-based membranes on a semi-industrial scale, based on analysis of lab-scale production. The costs of the ceramic supported membrane, metallic supported Pd-Ag membrane, ceramic supported Pd-Ag-Au membrane and ceramic supported double-skinned membranes were stated as 6,800 €/m<sup>2</sup>, 10,200 €/m<sup>2</sup>, 7,900 €/m<sup>2</sup> and 5,700 €/m<sup>2</sup> respectively.

### 3.3.3.14 Polymer Membranes

Polymer-based membranes have been used commercially for the separation of hydrogen from various refinery, petrochemical and chemical process streams. Examples include the PRISM membrane, sold by Air Products, and the polyseparation system, produced by Honeywell UOP.

Qualitative outlines of the relative rates with which molecules permeate through polymer membranes are outlined by GRASYS in Figure 13 and Air Liquide in Figure 14.

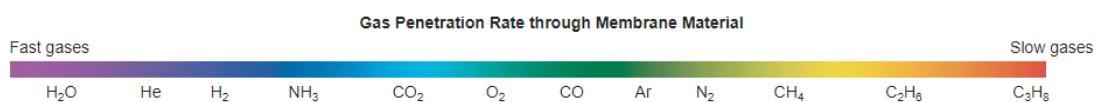
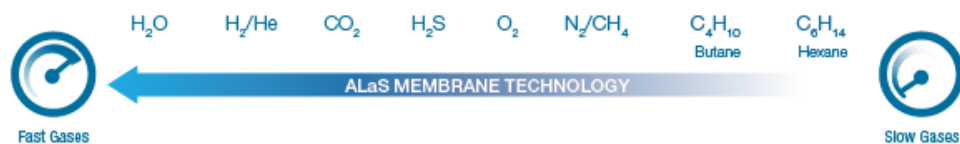

Figure 13: GRASYS gas penetration rate through polymer membranes (Source: [49])



**Figure 14: Air Liquide gas penetration rate through polymer membranes [29]**

Linde have developed the HISELECT polymer membrane in collaboration with Evonik [30], which can be used for hydrogen purification from synthesis gas. Correspondence with a stakeholder however, noted that membranes would produce hydrogen at low pressure and confirmed that this membrane is not suitable for purification in our cases considered. Instead they would recommend a PSA.

The PRISM membrane sold by Air Products [27] is used to separate hydrogen from hydroprocessing purge gas streams, separating hydrogen from hydrocarbons to purities of 85-95% with recovery rates of 85-95%.

Polyseparation membranes produced by Honeywell UOP [70] are used to produce purified hydrogen from off-gas streams in ammonia, methanol, gasifier and partial oxidation plants, typically with >98% purity and >95% recovery rate. This membrane is recommended for applications where the feed pressure is greater than 70 bar.

Air Liquide offer the ALaS Hydrogen Membrane System [29] for the recovery of hydrogen from refinery and petrochemical streams and the adjustment of H<sub>2</sub>/CO ratios in purge gases. ALaS membranes have been demonstrated with feed flows of up to 70,000 Nm<sup>3</sup>/h and are able to separate hydrogen from CO with attainable CO retention rates of >99 % and hydrogen recoveries of up to 98%, dependent upon the feed composition.

This may also be able to separate hydrogen from syngas. Further conversations with stakeholders will be required to determine their effectiveness on syngas.

Generon also produce membranes for H<sub>2</sub> and CO ratio adjustment in syngas. Their system separates H<sub>2</sub> and CO with purities of up to 95%, recoveries of 90-99% and flow rates of up to 560 000 Nm<sup>3</sup>/hr [71]

### Cost Data

The polymer membranes surveyed lose 2-15% of the hydrogen product. There will also be an additional cost associated with compressing hydrogen for injection into the grid.

There is a lack of literature data on the costs of polymer membranes, but we note that the literature describes polymer membranes as a low-cost purification method [31] [32].

### 3.3.3.15 Cryogenic / Low temperature separation

Cryogenic separation technology uses the difference in boiling points of gases to separate hydrogen. It is associated with high capital and operating costs due to the equipment complexity and energy required for cooling but produces carbon dioxide that is both dry (i.e. contains negligible water) and in liquid form, so no further processing is required for carbon capture. The technology is commercially available for nitrogen, oxygen, and carbon dioxide purification and can be used in hydrogen recovery from refinery off-gases.

When used in recovery from refinery off-gases, cryogenic separation can produce hydrogen with purities of 95-99 vol% with recovery rates of 90-98 vol%. Due to a high capital cost of the equipment and high refrigeration demand, it is generally only used when other liquid products are recovered in addition to hydrogen [72]. Cryogenic separation can also be used for the separation of hydrogen from ammonia purge gases [30], but is not widely used for large-scale hydrogen purification.

A discussion with a stakeholder suggested that if the purity requirement of hydrogen were relaxed to 96-97%, cryogenic separation might be an option. However, this may not be sufficiently effective in removing carbon monoxide, nitrogen and argon. Water would also need to be removed before the cryogenic purification was performed. It was hence recommended that cryogenics be used for bulk separation of hydrogen for further purification.

There are also examples of cryogenic technology being used for CO<sub>2</sub> capture in hydrogen production. Air Liquide offer the cryogenic Cryocap© technology [53] for carbon capture from a PSA off-gas stream. The technology also uses a polymer membrane to separate some hydrogen from a PSA off-gas stream to be recycled into the process, and has been applied to Air Liquide’s Port Jerome production plant serving an Esso refinery [74].

Tokyo Gas [63] have also demonstrated carbon capture from the off-gas of a membrane reactor using low temperature separation.

### Cost Data

The H21 report [31], looked at the costs of hydrogen liquefaction for storage. The total project cost for 3 liquefaction plants, with the total capacity to liquefy of 200 tonnes/day of hydrogen, was found to be £1,502 million. The energy required to liquefy hydrogen for storage is also noted to be 25 % of the energy content of the hydrogen. In purification by liquefaction, the hydrogen itself does not have to be liquified, and so these numbers provide an upper bound on the cost of using liquefaction for hydrogen separation.

### 3.3.3.16 Electrochemical

An electrochemical cell can be used to purify hydrogen as shown in Figure 15. Only hydrogen atoms are oxidised at the anode, and so can travel through the electrolyte to reach the cathode, where pure hydrogen is formed. As large-scale purification technology, this is at the demonstration phase, and has been studied in the MEMPHYS project [75] and the HyGrid project. [76] Both projects make use of the electrochemical cell alongside a membrane for purification. The MEMPHYS project designs a hydrogen purification system to allow the re-use of hydrogen from various industrial sources, and the HyGrid project targets hydrogen recovery from natural gas grids at 2-10 % hydrogen concentration.

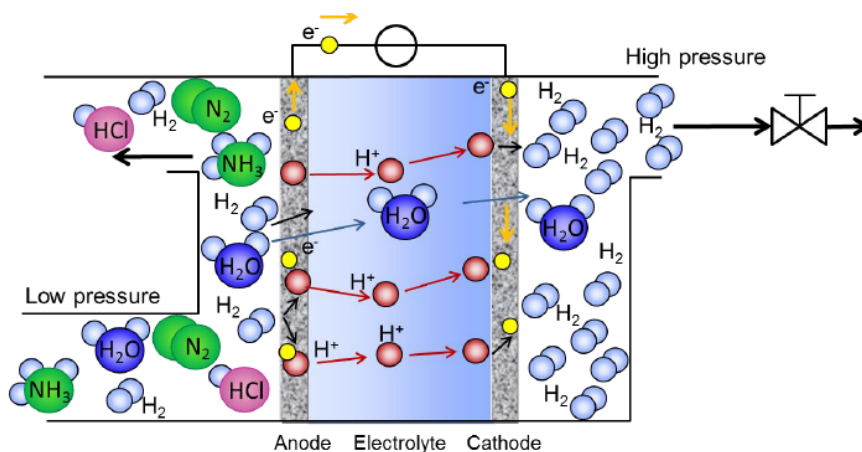

**Figure 15: Electrochemical purification [75]**

### 3.3.3.17 Methanation

In the methanation reaction, both carbon monoxide and carbon dioxide react with hydrogen to produce methane, in the reverse of the reformation reaction:

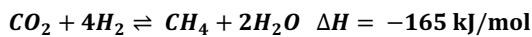
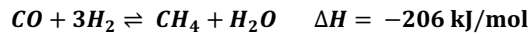

According to Ritter et al. [5], prior to 1980 the standard procedure to purify hydrogen was to use chemical absorption ("wet-scrubbing") to remove carbon dioxide from the process stream, followed by a methanation reaction to reduce the carbon oxide levels to 50 ppm. This results in a stream with 95-97% H<sub>2</sub>, 2-4% CH<sub>4</sub> and 0-2% N<sub>2</sub>. Example flowsheets in the same study note the use of a Ni based catalyst, 20 atm pressure and a temperature of 300-350°C for the methanation reaction.

The use of a highly selective catalyst can favour carbon monoxide conversion over carbon dioxide. Li et al. [77] and Ledjeff et al [78] have both studied methanation mechanisms able to reduce CO levels to below 10ppm.

Johnson Matthey sell their KATALCOTM range [79] of nickel catalysts for the removal of carbon oxides from synthesis gas. Haldor Topsoe also sell their PK-7R and PK-5 catalysts for methanation reactions [80].

#### Cost Data

We currently lack information on the costs of the methanation process, which we will continue to seek. Likely cost factors are the re-heating of the gas to the methanation reaction temperatures and the small amount of hydrogen product used in the reaction. The methanation reaction uses three hydrogen molecules for every molecule of carbon monoxide removed and four hydrogen molecules for every molecule of carbon dioxide removed. If the carbon monoxide level is reduced from 0.2 mol% of the syngas to 50 ppm, and CO<sub>2</sub> from 0.5% to similar levels, ~3% of the hydrogen product is used (Assuming methanation takes place after carbon capture and hydrogen makes up 93% of the syngas at this point). It may be the case that there is waste heat available in the reformer available to be used for heating the methanation reaction.

### 3.3.3.18 Water Electrolysis

Water electrolysis is based upon the following equation:

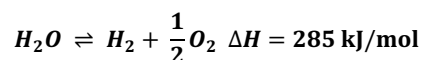

The process typically consists of the purification of tap water, which then feeds an electrolysis cell. The output hydrogen from the electrolysis cell then needs to be dried.

In the electrolysis cell, the anode and cathode are separated by an electrolyte; the choice of the electrolyte determines the electrolysis method. In order to create large capacity electrolysis plants, most manufacturers create a module of 5-10 MW and replicate this to produce systems in the 10s or 100s of MW. [81]

### 3.3.3.19 Proton Exchange Membrane Electrolysis

Proton exchange membrane water electrolysis (PEMWE) makes use of a proton exchange membrane as a solid electrolyte to separate the anode and cathode. Protons produced at the anode can pass through the membrane to reach the cathode, where they are reduced to produce hydrogen. The two half equations are shown below. The solid electrolyte means that cells can typically be more compact than in alkaline electrolysis.

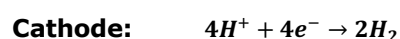
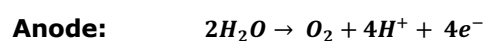

In PEMWE there is little permeation of impurities across the membrane, giving a purity of 99.99+% after drying. [42] In the UK, PEMWE is currently used for production of hydrogen on-site at hydrogen refuelling stations (HRS), on the 100 kW scale.

Typically, a temperature swing adsorption (TSA) is used to remove water from the product.

### Impurities Data

The EMPIR project [82] determined that nitrogen, water, oxygen and CO<sub>2</sub> may be found in the product. Nitrogen is typically introduced during venting for emergency shut-down or maintenance. Water and oxygen may permeate through the PEM into the product, while CO<sub>2</sub> may be found in the water feedstock, but should be removed during water purification. Other impurities may be found in the water feedstock but will be removed if the purification is functioning properly.

The EMPIR project examined seven hydrogen samples produced by PEMWE with TSA purification, and five samples produced by PEMWE without TSA purification. [82] This data is presented in Appendix D (Sampling Data). The samples that had been purified with TSA all met the ISO 14687-2 standard, while those without TSA did not meet the standard due to levels of water >100 µmol/mol. The unpurified samples also exhibited oxygen levels in the range 18-500 µmol/mol and carbon dioxide levels of 0.2-5.4 µmol/mol, which do not meet the ISO fuel cell vehicle requirements of 5 µmol/mol H<sub>2</sub>O, 5 µmol/mol O<sub>2</sub> and 2 µmol/mol CO<sub>2</sub>.

### Cost Data

The H21 report [21] gathered data from suppliers of PEMWE in the range 0.5-3.5 MW, finding energy consumption between 5.3 and 5.6 kWh per Nm<sup>3</sup> H<sub>2</sub> and water consumption of around 1 litre per Nm<sup>3</sup> H<sub>2</sub>.

The UKHFC report [33] predicts that in 2025, with an electricity price of 10 p/kWh, the cost of hydrogen produced by PEMWE will be 16 p/kWh.

### 3.3.3.20 Alkaline Electrolysis

In alkaline electrolysis (AEL) an alkaline solution such as potassium or sodium hydroxide [23], which conducts hydroxide ions, is used as the electrolyte. Water is reduced at the cathode to produce hydrogen and hydroxide ions, and the hydroxide ions conduct through the electrolyte to the anode where they are oxidised to produce oxygen and water. The two half equations are shown below.

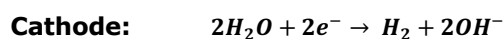

AEL is a more mature technology than PEMWE and it is deemed unlikely that significant further cost reductions will be achieved.

### Impurities Data

The EMPIR project [23] does not provide as much detail on the impurities expected to be present in AEL produced hydrogen, but notes that nitrogen, oxygen, water, argon and potassium/sodium ions may be present. Nitrogen and argon may be present due to insufficient purging after shutdown. Oxygen and water may also be present, as in the case of PEMWE, and potassium/sodium and hydroxide ions may be dissolved in any water present.

The HyCORA project [58] examined 18 samples produced by water electrolysis plants, which we note will include a TSA for water removal. Correspondence with the author of the project reports confirmed that only one of these samples was produced by PEMWE and the rest were produced by AEL. Of the AEL samples, two had levels of both inert gases and oxygen that were higher than the ISO limits. Two further samples had oxygen levels just above the ISO limits.



The RESelyser Project [83] developed a prototype AEL, which uses a novel anode-cathode separator to prevent hydrogen and oxygen crossover. Oxygen levels down to 50 ppm were found, above the 5 ppm ISO 14687 vehicle PEMFC specification. In order to reach higher purity levels a TSA will be required.

NEL produce an alkaline electrolyser, using a TSA for drying, which produces hydrogen to a purity of 99.9% [84]. Element Energy and E4tech [85] surveyed AEL manufacturers and found hydrogen purities, after non-optional purification steps, of 99.5 – 99.9998 % available.

#### **Cost Data**

The H21 report [21] gathered data from suppliers of AEL in the range of 0.5-3.5 MW, finding energy consumption between 4.4 and 5.1 kWh per Nm<sup>3</sup> H<sub>2</sub> and around 1 litre of water per Nm<sup>3</sup> H<sub>2</sub>. The cost and efficiency of a 1.5 GW AEL plant was modelled. The capital cost was estimated as £1,740m, or £1,160 per kW H<sub>2</sub> (HHV), and the efficiency estimated as 5.0 kWh/Nm<sup>3</sup> H<sub>2</sub>. This results in a cost of £155 /MWh H<sub>2</sub>. The report also notes that while AEL was selected as the most appropriate electrolyser, the market currently does not have the capability to supply 1-2 GW of AEL capacity within a year.

#### **3.3.3.21 Solid Oxide Electrolysis**

Solid oxide electrolysis (SOEL) is variation of electrolysis in which a solid oxide, which conducts oxide ions, is used as the electrolyte. Water is reduced at the cathode to produce hydrogen and oxide ions, and the oxide ions conduct through the solid oxide to reach the cathode where they are oxidised. The anode and cathode half equations are presented below.

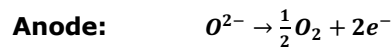
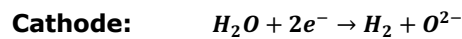

SOEL requires temperatures of 700-900°C but can achieve higher efficiencies than AEL or PEMWE. However, SOEL is still at the research stage, on the scale of single stack tests. [32]

#### **Impurities Data**

We currently have no data available on the impurities present.

#### **Cost Data**

Buttler et. al's review [42] of electrolysis suggests that due to the low TRL of SOEL the costs are uncertain. The report cites a report by E4Tech and Element Energy [65] which suggests costs of 1000 €/kW<sub>el</sub> will be achieved between 2020 and 2030, and 300 €/kW<sub>el</sub> in the longer term. The report also cites a US DoE report which suggests an uninstalled cost (not connected to utilities) of 340 €/kW<sub>el</sub> by 2025 [66] for a 50,000 kg/day (70 MW LHV) system. The review also estimates energy consumption in the range of 3.7-3.9 kWh per Nm<sup>3</sup> H<sub>2</sub>.

#### **3.3.3.22 Purification of Electrolysis Produced Hydrogen**

Temperature swing adsorption (TSA) is typically used to dry hydrogen produced by water electrolysis. First the gas is cooled, and the water that condenses is removed. Next, any small amount of oxygen impurity is reacted with the hydrogen to produce water using a catalytic deoxidiser, and the resulting wet hydrogen is passed through the TSA unit.

A TSA unit usually consists of two columns filled with desiccant. At any given time, one column is used to adsorb moisture from the product whilst the other is regenerated. [23], [84]

#### **Impurities Data**

In section 3.3.3.19, the impurities found in samples of hydrogen produced using PEMWE with and without TSA were described. All of the samples with TSA met the ISO 14687-2 specification for fuel cell vehicles.

### **Cost Data**

Typically, a temperature of 200-250°C is used for regeneration [23], and the column is then flushed with pure hydrogen. The hydrogen consumption and power usage of a characteristic TSA, as given in a review of PEMWE by Bessarabov and Millet [67], are <10% and 1 kW(Nm<sup>3</sup>/h)<sup>-1</sup> respectively. A techno-economic analysis of PEM electrolysis by SA and NREL [14], found the dryer to use 3-4% of the gross hydrogen production for regeneration and 1.25 kWh electricity per kg H<sub>2</sub>. The capital cost of a TSA unit was estimated in discussions with stakeholders to be approximately 5% of the capital cost of the electrolyser.

### **3.3.3.23 Hydrogen Import**

In the future, hydrogen may also be imported, for example from countries with a high renewable energy generation capacity where hydrogen is generated by electrolysis. Hydrogen can be imported in either liquid or compressed form.

The HyCORA project did not study the impact of hydrogen transport method directly but did collect data from hydrogen refuelling stations with hydrogen produced off-site and transported in both liquid and compressed forms. This data is presented in Appendix D (Sampling Data) and will be used to give an indication of the impurities that might be picked up by hydrogen transported in liquid or compressed form.

The project sampled hydrogen from fourteen refuelling stations where the hydrogen had been transported in compressed form. Of these samples, two had been produced by an SMR off-site, six by water electrolysis (WE) off-site and three by WE on-site. For the remaining three samples it is unclear whether the hydrogen is produced on or off-site. Only four of these samples did not meet the ISO 14687-2 fuel cell vehicle specification, with oxygen levels slightly higher than the 5 ppm limit. Two of these high oxygen samples also had inert levels above the ISO limit. The ten samples that meet the ISO 14687-2 standard demonstrate that hydrogen transported in compressed form is capable of meeting the most stringent standard that we consider.

The project also collected data from six samples produced off-site by an SMR (with PSA) and stored in liquid form. Of these samples, four meet the ISO 14687-2 standard and two had slightly higher oxygen levels than allowed by this standard. The four samples that meet the ISO standard demonstrate that hydrogen transported in liquid form is also capable of meeting the most stringent standard that we consider.

### **3.3.3.24 By-product**

Hydrogen is produced as a by-product of processes such as chlor-alkali production, cyanide, styrene and ethylene production and refinery processes [44].

A study of industrial sources of hydrogen in the North Rhine-Westphalia (NRW) area [88] provides an overview of the potential availability of hydrogen produced as a by-product from different sources, including coke oven plants and chlor-alkali plants. The coke oven plants reported no surplus hydrogen availability, as the hydrogen produced is integrated in a combined coke oven and steel works. Similarly, the chlor-alkali plants studied had balanced production of hydrogen with on-site demand, leaving no surplus availability. It is anticipated that a similar situation will be found with UK production.

### **3.3.3.25 Refineries**

Refineries produce hydrogen during thermal cracking, catalytic cracking, catalytic reformulation of crude oil and as a by-product of coke production. They also make use of hydrogen in hydrocracking, hydration of cokers, gasoline hydrotreating and distillates hydrotreating. [44] The balance of production and consumption

of hydrogen depends upon the exact refinery, but often refineries are net consumers of hydrogen and will install SMR plants to meet their hydrogen demands. [43]

### 3.3.4 UK Hydrogen Production

A summary of the major UK hydrogen production sources is shown in Figure 18. A list of the sites is shown in Appendix 2. Captive hydrogen is that used on-site, largely in refineries, while by-product and merchant compressed gas are sold to other users.

This data is collated from H2tools 2015 data [89], the 2008 roads2Hy project [44] and the 2012 UK H2mobility project.

SMR producers currently use PSA for production. The two current owners of SMR are BOC and Air Products. BOC currently produce to the specification of 99.98% hydrogen with oxygen <5 ppm, water <8 ppm, total carbons <10 ppm and nitrogen <100 ppm [90]. Correspondence with a stakeholder at BOC confirmed that their current hydrogen capacity is sold to an existing market.

The electrolytic hydrogen production capacity shown consists of PEM electrolyzers. The Inovyn co-product plant in Runcorn produces hydrogen as a by-product of chlor-alkali production and the Exxonmobil site in Fife is an ethylene producer.

Total hydrogen production in the UK (including the captive production used on-site) is  $2.4 \times 10^8$  kg/year, or 8.1 TWh/year. We note that this is well below the  $\approx 490$  TWh of natural gas used across the domestic, industry and services sector in the UK in 2017 [91]. Widespread use of hydrogen for heating would therefore clearly require new hydrogen production facilities.

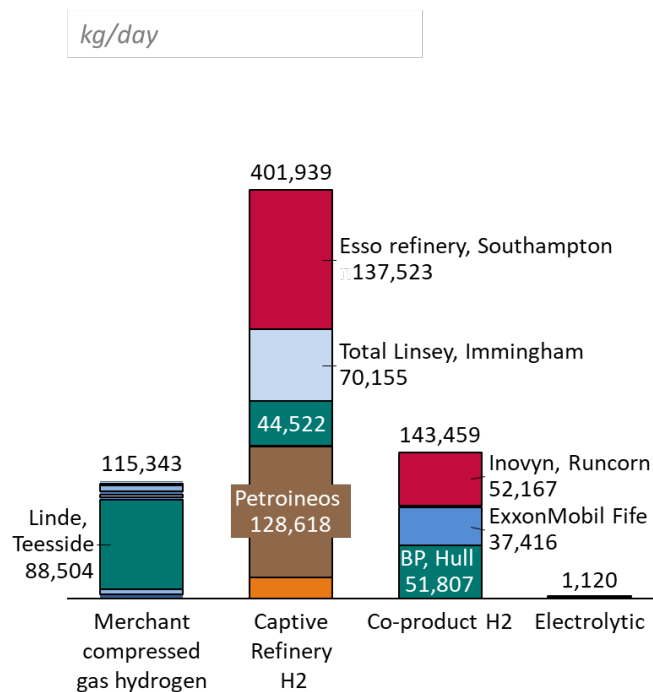

**Figure 16: UK Hydrogen production by source**

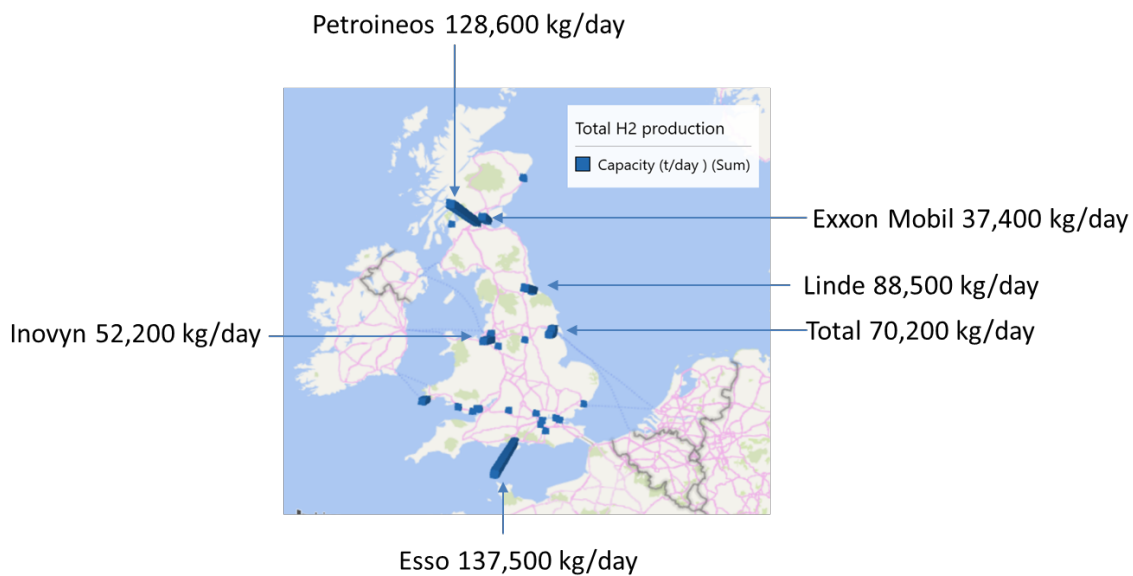

**Figure 17: UK hydrogen production by location**

### 3.3.5 Summary of projects describing impact of hydrogen purity on production cost

Much of the work published on hydrogen production and purification methods focuses on producing to the ISO 14687-2 specification for fuel cell vehicles, which requires 99.97% mol hydrogen and has stringent limits on carbon monoxide and inert gases [92]. Few reports have described the impact of varying the hydrogen purity requirement on production costs. Those reports that have considered this impact in some way are briefly summarised here. They include the H21 North of England report [21], the Leeds City Gate Report [21], [93], the Biohydrogen project [26] and the Kiwa/E4tech study on the development of a hydrogen-fired appliance supply chain [94].

The Kiwa/E4tech study included a survey of manufacturers of hydrogen appliances, and reported responses on how the purity level 99.5%, 99.9% and 99.999% H<sub>2</sub> might affect appliances. The study found that the important factor in determining the impact on appliances is the level of specific impurities, such as H<sub>2</sub>S or CO, rather than the overall hydrogen purity percentage.

The H21 North of England report suggests the use of an ATR with carbon capture using aMDEA, but no further purification, to produce hydrogen to a purity of 98.4%. However, the report does not provide further detail on the identity of the impurities making up the remaining 1.6%. A discussion with a stakeholder noted that this would include 0.4-0.6% CO and 0.2-0.4% methane.

The Leeds H21 City Gate project suggested the production of 99.98% pure hydrogen with CO <15 ppm, CH<sub>4</sub> <100 ppm and CO<sub>2</sub> <10 ppm. It is worth noting that this report was published before the H21 North of England report described above, in which the suggested purity requirement is reduced.

The Progressive Energy/APP Biohydrogen report suggests a limit of 2% non-combustibles, in order for a 20% H<sub>2</sub> blend in natural gas to meet the Wobbe number required by the GS(M)R for natural gas. The report suggests that limits on sulphur species and organohalides should match the GS(M)R specification. A limit for carbon monoxide is proposed based upon the 15 minute Workplace Exposure limit for carbon monoxide of 200 ppm; a conservative limit of 100 ppm CO is suggested, with a note that a higher limit maybe also be safe.

### 3.4 Data from the GDNO's

The Hy4Heat WP2 team identified that gas distribution companies have significant knowledge and information on the presence of impurities and issues regarding gas pipeline operations that may be impacted by the underlying composition of the gas. Although their experience relates in the most part to natural gas, there is still historical information on the distribution of "Town Gas".

The Hy4Heat WP2 team have focused on two topics with the GDNOs, namely requirement for colourant in the network and for pipeline purity requirements. For the current report, only the pipeline purity aspects are included.

Contact with gas quality and network integrity experts from the GDNOs has been made and although their primary focus is on natural gas quality and composition, comments were made on hydrogen purity. To act as a framework for the discussions, outline information on purity from the Standards review and production methods, described in earlier sections, was used.

The over-riding consensus view from discussion with gas quality experts in GDNOs was that distribution of hydrogen through a complex, multi-connected pipeline network is not conducive with ultra-high purity requirements. The nature of the pipeline (materials, operation and hydrogen gas sources), maintenance activities and repairs (to meet operational and safety requirements) mean that it is inevitable for the purity to be impacted.

The specific points mentioned include:

- Odorant
- Oxygen content
- Carbon monoxide content
- Water dewpoint (concentration)

Odorant addition is a key requirement for compliance with pertinent HSE legislation currently applied to natural gas distribution to end-users and almost certainly needed for hydrogen used for the same purposes. Odorant options for hydrogen from part of the SGN "Hydrogen 100" study and information has been requested relating to the output from that study. From a GDNO operations viewpoint, the odorant used for hydrogen should not introduce any additional risks over those already covered for natural gas distribution and must not adversely affect the health of their rhinologists (or other engineers) in the course of their day-to-day operational activities.

The presence of up to 2% inert gas in the hydrogen was not viewed as an issue for the distribution networks, as this level is similar to the value present in several natural gas qualities.

Oxygen limits similar to those accepted for natural gas in the GS(M)R [1], together with contractual limits from Network Entry Agreements could be adopted for hydrogen distribution networks. The flammability limits of hydrogen with oxygen are very wide with quoted ranges of 4 – 95%, and a limiting oxygen content (LOC) for flammability of around 4%. The oxygen concentration limit in hydrogen should be significantly lower than this LOC.

Carbon monoxide content was also discussed, both from the point of view of potential health impacts on the GDN operations engineers, and on their current gas detection equipment. The acceptable concentration of carbon monoxide in hydrogen should be lower than any environmental or occupational health thresholds currently in place. Guidance from the Health and Safety Executive with regard to environmental health is provided in their EH/40 document (Second edition published in 2011), and the short-term and long-term exposure limits for carbon monoxide are 200 and 30 ppm respectively (or 232 and 35 mg/m<sup>3</sup>).

In November 2017 to February 2018, a UK wide consultation on selected limits in EH/40 was undertaken by the HSE and this included carbon monoxide. The proposed new short and long-term exposure limits are 100 and 20 ppm respectively (or 117 and 23 mg/m<sup>3</sup>). As there is potential for exposure to the pipeline gas during routine operational and maintenance activities, it is sensible to ensure that the low-level carbon monoxide content in hydrogen does not breach any operational exposure limits. For natural gas, the criteria of 20% LEL (or 1% gas in air concentration) is used as a threshold for an operative to put on breathing apparatus, and it is also the setting used for odorant checks by trained rhinologists.

To ensure that operatives are not exposed to carbon monoxide concentrations of 20 ppm then the limit in hydrogen must be no greater than 2000 ppm. For further guidance, the EU air quality exposure limit for carbon monoxide is 10 mg/m<sup>3</sup>, if this is present in a hydrogen / air mixture at the LEL of the fuel, then this is equivalent to around 250 mg/m<sup>3</sup> in the hydrogen fuel gas, which is approximately 200 ppm (see section 3.1.5)

Water content was raised as a concern from the viewpoint of liquid drop-out and of promoting corrosion, both of which will impact on pipeline network integrity and flow control. The general concept of delivering a “dry gas” was thought to be a suitable approach and as such water concentration limits similar to those for natural gas could be adopted. The limits are not given in terms of a concentration but as a water dewpoint temperature at a specific pipeline pressure. The limit is a water dewpoint of -10°C at 85 barg.

### 3.5 Assess Impurity Level at Point of Use

The Hy4Heat WP2 team have collated information on the purity requirements and used the information in discussion with end-user stakeholders.

General comments from the stakeholders have focused on overarching characteristics including:

- The fuel gas should be non-toxic and not produce hazardous combustion products
- The impurities should not impact on the utilisation process i.e. impact on flame stability or fundamental combustion processes
- The impurities should not affect any gas or flame detection systems
- For boilers, the impurities should not influence the acidity of the condensate nor affect the integrity or operation of the heat exchangers

The potential impurities considered were ones that may originate from the production and purification processes, discussed in previous sections, and also components identified in the Standards review work (as detailed above and in the Appendices). Impurities may also be introduced through the transmission and distribution of the fuel gas through the pipeline network, either as known additives like odorant or as contaminants produced in the pipeline like corrosion products.

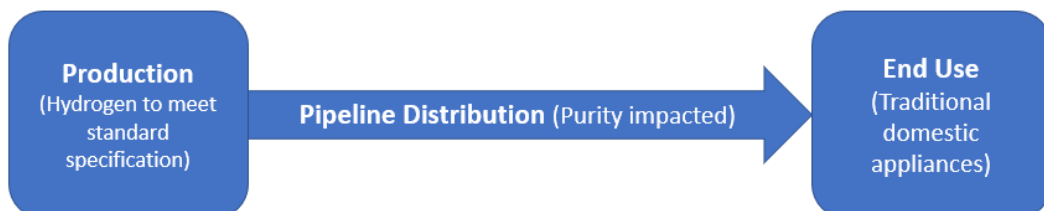

**Figure 18: Schematic concept for hydrogen purity at point of use**

The anticipated range of impurities from the production process includes:

- CO
- CO<sub>2</sub>
- CH<sub>4</sub>
- N<sub>2</sub>
- Ar
- H<sub>2</sub>O
- O<sub>2</sub>
- H<sub>2</sub>S

For traditional domestic appliances the impact of these species, at relatively low concentrations, should not impact on the overall operation.

In addition to the species listed above, pipeline operations may introduce further trace contaminants, including odorant, sealant materials, oils and greases, and especially solid corrosion products (scales, rusts and particulates).

Normal pipeline network operations includes particulate filtration and liquid traps, so it is not anticipated that any of the above species will have greater impact in a hydrogen network compared to natural gas.

One area that requires further study is the potential for sulphidation in copper pipework within a domestic property. This is a known phenomenon for natural gas and results from reaction of H<sub>2</sub>S with the copper surface. It forms a black dust which can impact on valves and burners if it is not trapped. The overall mechanism is not fully understood but information from an HSE report (CRR00287) states that H<sub>2</sub>S concentrations in excess of 0.4 mg/m<sup>3</sup> can result in the formation of the sulphidation dust, although the impact is greater when the concentration is above 1 mg/m<sup>3</sup>. The incidence is greatest in north west England and is managed by the installation of in-line filters.

The proposed formation mechanism for sulphidation dust requires not only H<sub>2</sub>S to be present but other components, including oxygen, water and carbon dioxide. As all of these could be present in pipeline hydrogen there is potential for sulphidation to occur although the extent and consequences are not known at present.

### 3.6 Output from the SGN Hydrogen 100 Project

The SGN Hydrogen 100 project has investigated the technical requirements for a dedicated, new hydrogen distribution network. A key task within the Hydrogen 100 project is to

*“identify an appropriate odorant for distributed hydrogen, preferably with a similar sulphurous smell to existing natural gas and compatible with appliances and fuel cells”.*

Information from the SGN Hydrogen 100 project has been obtained, focusing on the odorants and impurities. This data is being reviewed and key aspects will be included in the final report.

It is anticipated that a recommendation on a suitable odorant for WP9 will be made, together with a longer-term view on odorant options for future wide-scale deployment of hydrogen, recognising the requirements for the wide range of end-user stakeholders.

The evaluation of the odorant and other components provides an up-to-date test on the requirements for a hydrogen odorant and assists in developing the “draft hydrogen purity recommendation” task within this current study.

Information from the SGN Hydrogen 100 project has been obtained, focusing on the odorants and impurities. This data is being reviewed and key aspects will be included in the final report. Five odorants have been identified through a literature review:

1. Odorant NB (78% TBM, 22% DMS) – This is the primary odorant used by SGN and other gas networks
2. Standby Odorant 2 (34% Odorant NB, 64% Hexane) – A diluted form of odorant NB used by SGN if supply of odorant NB is compromised
3. Odorant THT (100% THT) – The most commonly used odorant within European gas networks
4. GASODOR-S-FREE (37.4% MA, 60.1% EA, 2.5% EMP) – This is a sulphur free gas odorant in use within some German gas networks
5. 5-ethylidene-2-norbornene – this is an odorant with an unpleasant odour that is suitable for fuel cell applications

Olfactory testing (characterisation of smell) has indicated that all compounds are suitable as an odorant for hydrogen in the gas grid except for 5-ethylidene-norbornene which did not pass the unpleasantness criteria (i.e. if detected in a kitchen it may not be unpleasant enough to provide a warning).

A Health and Safety assessment by HSE confirmed that there were no issues with these compounds at the concentration levels they would be present in detection of a gas leak.

The tests that are now underway are planning to investigate how these five odorants affect boiler degradation, pipeline (both stainless steel and polyethylene) and fuel cells as found in hydrogen fuel cell vehicles. Two of the odorants were selected as they were deemed to be suitable for fuel cells (the non-sulphur odorants).

<b>Odorant</b>	<b>Component</b>	<b>Amount/Fraction (<math>\mu\text{mol} / \text{mol}</math>)</b>
<b>NG 812</b>	<b>2-methyl-propanethiol</b>	<b>1.51</b>
	<b>Dimethyl Sulphide</b>	<b>0.426</b>
<b>NG 817</b>	<b>Hexane</b>	<b>1.28</b>
	<b>2-methyl-propanethiol</b>	<b>0.514</b>
	<b>Dimethyl Sulphide</b>	<b>0.415</b>
<b>NG 845</b>	<b>5-ethylidene-norbornene</b>	<b>17.0</b>
<b>NG 815</b>	<b>Ethyl acrylate</b>	<b>1.124</b>
	<b>Methyl acrylate</b>	<b>0.699</b>
	<b>2-ethyl-3methylpyrazine</b>	<b>0.047</b>
<b>NG 846</b>	<b>Tetrahydrothiophene</b>	<b>4.99</b>



	<b>All criteria passed</b>
	<b>All criteria passed except for unpleasantness criteria</b>

**Table 21: Odorant Suitability for Fuel Cells**

It is anticipated that a recommendation on a suitable odorant for Hy4Heat Work Package 9 (WP9) will be made, together with a longer-term view on odorant options for future wide-scale deployment of hydrogen, recognising the requirements for the wide range of end-user stakeholders.

The early indication is that the odorant concentration will be similar to that required for natural gas. The SGN Hydrogen 100 project will evaluate the odorant concentration required. The odorant concentration will impact on the sulphur content and this is accommodated within the proposed purity specification.

### 3.7 Liaise with Cadent HG2V Project

The Cadent HG2V (Hydrogen Grid to Vehicles) project is evaluating the potential feasibility to use the existing natural gas network as a carrier for hydrogen to be used in fuel cell vehicles (FCVs). The hydrogen could be in a dedicated, repurposed natural gas pipeline or in an existing pipeline as a blend with natural gas. The project is evaluating the impacts of trace components on hydrogen purity and separation and clean-up technologies that could be employed to ensure that the hydrogen delivered to an FCV refuelling station meets the stringent purity requirements.

This HG2V project will produce useful supporting information for the Hy4Heat programme in that it will identify and quantify a wide range of trace contaminants. The Hy4Heat programme will be able to use this information to support the purity specification and also highlight any potential impact from trace impurities on traditional domestic appliances rather than FCVs.

Information from the Cadent HG2V project will be included in the Hy4Heat WP2 report but, at present, there are no reports available. The HG2V project timescale does not coincide with the Hy4Heat WP2 purity project, so early information from the project will be considered and included in the final report.

A workshop on the aims of the HG2V project and the range of impurities that may be present was held at NPL on 29<sup>th</sup> January 2019. The output from the workshop has supported and endorsed the current Hy4Heat purity themes highlighting that the key impurities may be carbon monoxide and sulphur-containing species depending on the hydrogen production method. The topics of the odorant and colourant requirement were also discussed and an overview of the information has been included in this current report.

### 3.8 Recommend optimum Purity Level

The output of the review of hydrogen purity requirements based on the work undertaken for this study is the recommended purity shown in Table 1.

Content or characteristic	Value	Rationale
Hydrogen fuel index (minimum mole fraction)	98 % ( $\text{cmol mol}^{-1}$ )	This value is a good compromise between hydrogen cost and effects on boiler.
Carbon monoxide	20 ppm ( $\mu\text{mol mol}^{-1}$ )	A practical engineering limit based on achievable production limits and to meet long term exposure limits HSE EH/40)
Hydrogen sulphide content	$\leq 5 \text{ mg m}^{-3}$ 3.5 ppm ( $\mu\text{mol mol}^{-1}$ )	These values are taken from GSMR:1996 as any detrimental effects would be similar for hydrogen and natural gas, in a repurposed pipeline network.
Total sulphur content (including $\text{H}_2\text{S}$ )	$\leq 50 \text{ mg m}^{-3}$ 35 ppm ( $\mu\text{mol mol}^{-1}$ )	
Oxygen content	$\leq 0.2 \%$ ( $\text{cmol mol}^{-1}$ )	
Hydrocarbon dewpoint	-2 °C	Complies with GSMR:1996 and EASEE-gas, and avoids liquid drop-out
Water dewpoint	-10 °C	
Sum of methane, carbon dioxide and total hydrocarbons	$\leq 1 \%$ ( $\text{cmol mol}^{-1}$ )	No detrimental effects to boiler, this limit is to reduce carbon content of the exhaust
Sum of argon, nitrogen and helium	$\leq 2 \%$ ( $\text{cmol mol}^{-1}$ )	To avoid transporting inert gases with no calorific value in the hydrogen gas (in agreement with ISO/FDIS 14687) and to limit the impact on Wobbe Number (see below)
Wobbe Number range	42 – 46 $\text{MJ m}^{-3}$	Range and percentage variation based on natural gas range in GSMR;1996  Wobbe Number is calculated at UK metric standard conditions of 15 °C and 101.325 kPa
Other impurities	The gas shall not contain solid, liquid or gaseous material that might interfere with the integrity or operation of pipes or any gas appliance, within the meaning of regulation 2(1) of the Gas Safety (Installation and Use) Regulations 1998, that a consumer could reasonably be expected to operate	

**Table 1: Draft recommendation for a UK hydrogen quality standard for heat applications based on existing standards and documents**



The stakeholder engagement exercise undertaken and based on the proposed specification shown above has identified several challenges. These are discussed in Section 3.1.4, but focus on the minimum hydrogen content, the concentration of carbon monoxide and carbon dioxide that may be present and the approach to characterising water content as a dewpoint rather than concentration limit.

The recommended optimum purity will be required to account for a wide range of factors and the content of Table 1 may need to be revised as this project progresses and further information becomes available.

At the present time, and for the purposes of the WP9 occupied field trial, it is suggested that a distribution pipeline purity specification is developed. This specification will be appropriate for traditional domestic appliances (boilers, cookers and fires) but may not be suitable for domestic and commercial fuel cell installations.

## **4 HYDROGEN PURITY LEVEL ASSESSMENT (OTHER OPTIONS)**

For some applications, higher purity hydrogen may be required, and this may not be achievable through a pipeline network. Additional processing could be an option, but the technologies and scale of operation will influence the overall viability. In this section, the purity level requirements for selected downstream application are highlighted and options for clean-up discussed. Finally, a cost benefit approach identifies the techno-economic impacts.

### **4.1 Quantify Purity Levels for Downstream Applications**

Building on the purity assessments and information collation on hydrogen standards, it is clear that different purity levels are required for the wide range of possible end-user technologies.

Traditional domestic appliances (boilers, cookers and fires) are rather tolerant with regard to hydrogen content and impurity levels. Hydrogen content could be reduced but the other components have to be considered carefully. The presence of carbon-containing species would produce carbon dioxide and impact on the degree of decarbonisation, and the resulting fuel-type would resemble "Town Gas". There could be benefits to higher impurity levels as these could increase flame colour and also flame ionisation, both of which would be useful from the practical utilisation point of view.

However, management and control of the hydrogen composition would become more difficult as different sources could produce different qualities and how these different gases mix and distribute within the pipeline networks could impact on the final fuel quality received by an end-user. This may require an interchangeability approach similar to that for natural gas (and historically for town gas also). The variation in purity levels would also impact on the calorific value and the benefit of a higher hydrogen purity with a defined CV would be negated and additional hydrogen gas quality measurements may be required to ensure that end users are billed on the correct energy use.

In Task 1, this study has concluded that for the majority of domestic end-use applications the proposed hydrogen purity will be suitable, and the range and concentration of trace components should not have a major impact on the operation of the appliances.

As already noted, the recommended purity is not high enough to meet the requirements for PEM fuel cells (either stationary or vehicular), and additional clean-up will be required. (The purity requirements for PEMs are shown in the Appendices for ISO 14687.)

Although PEM fuel cells require high purity hydrogen, other fuel cells (solid oxide (SOFC) or molten carbonate (MCFC)) may be more tolerant of the hydrogen purity, although these applications may need to incorporate a scrubber to remove the odorant as sulphur species are known to be problematic.

### 4.1.1 Supporting Information on 2,000 ppm limit for O<sub>2</sub>

The proposed oxygen content limit for a hydrogen purity specification is based on consideration of impacts on material integrity through corrosion and on flammability.

Flammability limits are an important consideration for transportation of fuels, and for gases the impacts of temperature and pressure as well as the presence of trace components are key factors.

For hydrogen, it is known that there are very wide flammability limits for combustion in air and that the upper flammability limit increases significantly if the oxidant is oxygen rather than air. For hydrogen in air and oxygen at 20°C and atmospheric pressure the flammability limits are shown in Table 22.

Characteristic		Limits in air (mol%)	Limits in oxygen (mol%)
Lower flammability limit	LFL	4.3	4.0
Upper flammability limit	UFL	76.5	95.2

**Table 22: Flammability Limits [117]**

The flammable range widens if the initial temperature increases. The impact of initial pressure is more complex, but it appears as though the range narrows slightly.

As the focus here is on hydrogen purity and the acceptable oxygen content for pipeline distributed gas the main consideration is to ensure that the composition in the pipeline is significantly outside of the flammable range. The proposed limit of 0.2 mol% (or 2000 ppm) is substantially lower than the limiting oxygen concentration (LOC) which is quoted as 4.3% at room temperature. This LOC decreases to 1.3% at 400°C [118] but is still greater than the proposed oxygen limit in the hydrogen specification.

Thus, from the point of view of flammability the 0.2 mol% limit is appropriate.

With regard to pipeline integrity, as long as the hydrogen is dry there should be no significant impact from the presence of trace levels of oxygen. In a study on "hydrogen assisted fatigue crack growth" (HA-FCG) it was found that oxygen concentrations around 1000 ppm could inhibit crack growth [119].

Finally, as the 0.2 mol% has been successfully employed in the Gas Safety (Management) Regulations for natural gas, it is suggested that this is an appropriate limit to introduce for pipeline delivery of hydrogen (where pipeline pressures are similar to those in the current natural gas network).

### 4.1.2 Supporting Information on carbon monoxide and methane limits in the purity specification

The carbon monoxide limit proposed was 200 ppm and the combined total of methane, carbon dioxide and other hydrocarbons is 1%.

The proposed limits aim to accommodate the different, current production methods for hydrogen (and potential future production methods) and try to balance the potential for trace contaminants together with potential impacts on end-users.

The carbon monoxide limit was based on the HSE guidance through the EH/40 document [120] where the value is that for the short-term exposure (15 minute) is 100 ppm. It was assumed that exposure to the hydrogen gas would be through leakage and dispersion in air with a minimum of 20:1 dilution by the time the gas comes into contact with a human resident. The hydrogen will be odourised and so any leakage will be detectable at concentrations much lower than 5% in air. (In fact, the leakage should be detectable at

concentrations lower than 1% in air and as such the contact with carbon monoxide will be low.) The aim for setting the limit was to ensure that the house occupants would not be exposed to carbon monoxide concentrations as high as the long-term exposure limit of 20 ppm, and with the dilution factor assumed the exposure will be to 10 ppm as a maximum.

The proposed limits for methane, carbon dioxide and other hydrocarbons built on the values present in other standards (SAE J2719 and ISO 14687 (Type I, grade A), and recognised that if the minimum hydrogen content was 98% then the total for the other components must be up to 2%. Clearly there must be material balance and if the content of inert gas is up to the 2% limit then the other components must be significantly lower than their proposed limits.

The initial proposed values were targeted for hydrogen use in traditional burner systems for heating and cooking. The proposed limits for methane and carbon dioxide will have very little (or no) impact on traditional combustion systems for domestic appliances, nor will they impact pipeline integrity.

It should be noted that all of the limits could be reduced, with a potential impact on hydrogen production costs.

#### 4.1.3 Potential Wobbe Index range for the purity specification

Although the initial approach developed for the hydrogen purity specification focussed on proposing a minimum hydrogen content, the presence of trace components can impact on the energy delivery to traditional burners, and this is best addressed through consideration of the Wobbe Index (or Wobbe Number). The majority of domestic gas appliances are designed to deliver the energy required through a nozzle or injector into a burner assembly. The flow of gas through the nozzle is dependent on the supply pressure, the orifice diameter and the gas density. The heat input is the flow rate multiplied by the calorific value. It can be shown that for a particular orifice that the heat input is directly proportional to the Wobbe Number, where Wobbe Number is defined as:

$$Wobbe\ Number = \frac{Calorific\ Value}{\sqrt{Relative\ Density}}$$

This approach was adopted by the Gas Safety (Management) Regulations (GSMR1996) for natural gas and can be used for hydrogen to accommodate varying amounts of trace components.

The reason for proposing to include Wobbe Number in the specification is that although the trace component concentrations are low, as they are substantially larger molecules than hydrogen, they can have a significant impact on the "Relative Density" and thus on the energy to be delivered to an appliance through a burner nozzle.

The impact on the CV and WN with addition of nitrogen and CO<sub>2</sub> is shown in the following diagram, for additions up to 3 mol%. The impact on CV is a linear decrease in relation to the inert gas content (and is the same irrespective of the diluent being N<sub>2</sub> or CO<sub>2</sub>). Thus 3 mol% addition of nitrogen reduces the CV by 3%. This is a change from 12.1 MJ/m<sup>3</sup> to 11.74 MJ/m<sup>3</sup>.

The impact on Wobbe Number is not linear reflecting the inverse relationship to the square root of the Relative Density, and the trend with addition of nitrogen or carbon dioxide is different, as they are molecules of different molecular weight (and density). 100% pure hydrogen has a Wobbe Number equal to 45.89 MJ/m<sup>3</sup> (at the reference conditions of 15°C and 1.01325 bar).

Dilution with 1% CO<sub>2</sub> reduces the Wobbe Number to 41.33 MJ/m<sup>3</sup>, a decrease of around 10%. Although the decrease with nitrogen addition is smaller, the impact is still significant, as can be seen in Figure 19:

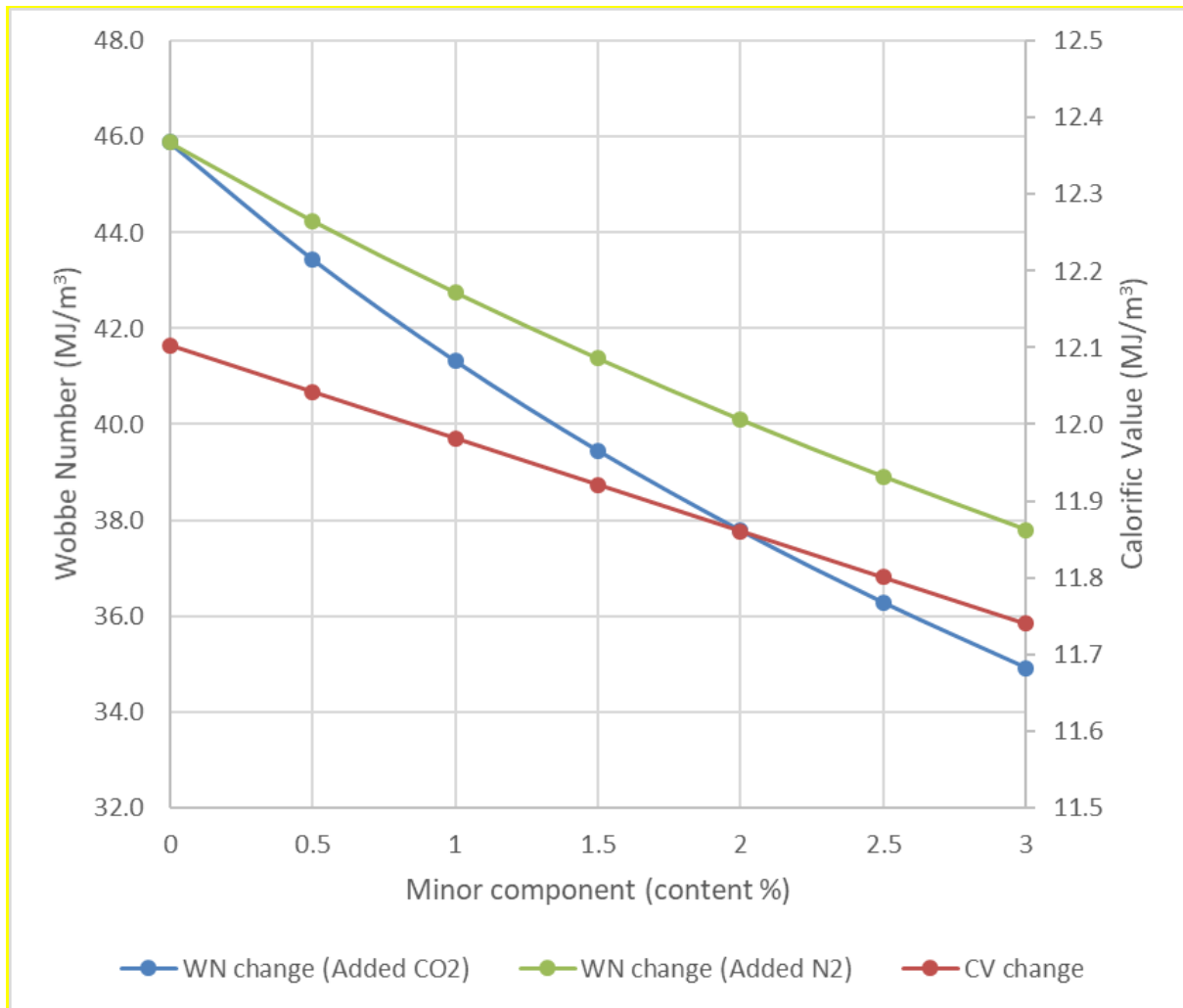

**Figure 19: Impact on Wobbe Number through CO<sub>2</sub> Dilution**

For natural gas, the Gas Safety (Management) Regulations limits gases to a Wobbe Number range from 47.2 to 51.4 MJ/m<sup>3</sup>, and this is around an 8% range.

As this range can be accommodated by current gas appliances, it is suggested that a similar one can be used for hydrogen.

It is proposed that a Wobbe Number range is included in the specification, and this could be 42 – 46 MJ/m<sup>3</sup>. Although it is recognised that this will provide further constraint on the acceptable trace component concentrations, it is suggested that the current concentration limits remain in the specification.

This approach will require discussion with appliance manufacturers and notified bodies for testing and certification (Hy4Heat WPs 3 and 4) and should be regarded as a proposed Wobbe Number range at present.

## 4.2 Practical & Commercial Feasibility of Delivering Hydrogen

Fuel cells and catalytic combustion systems require much higher purity hydrogen, and this is reflected in the data tables shown in Appendix A.

The general response from GDNOs is that it is not feasible to distribute such high purity hydrogen, and so alternative approaches are required to deliver this fuel quality. If high purity hydrogen is not produced then this might reduce costs at that stage, but additional clean-up costs may be required close to the end user.

The size and cost of any localised clean-up equipment is dependent on the location and duty of the process.

Two concepts are being considered; the first is pipeline supply to an embedded, integrated clean-up system and then a bespoke hydrogen microgrid system developed for a small number of users (Figure 20); the second is clean-up systems for individual users (Figure 21).

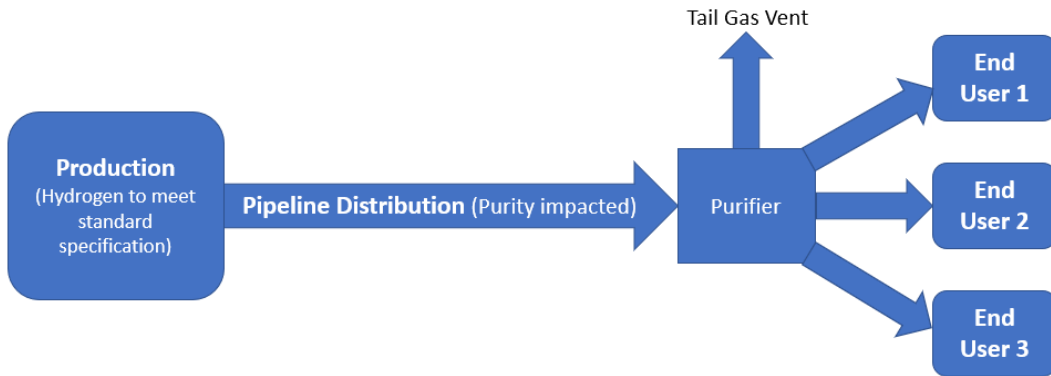

**Figure 20: Distributed purification stage with output feeding multiple end users (requires a tail-gas vent).**



**Figure 21: Suggested approach for specific purity-sensitive application**

The rationale for the two outline concepts is:

- Commercial purification methods (as outlined in earlier sections) tend to be for higher flows
- Commercial purification methods tend to require tail gas venting which is not appropriate for domestic installations. Venting at larger installations may be possible although if the vented gas contains
- Reintroduction of tail gas into the network is not considered. The concentration of the contaminant species will be higher in the tail gas and although it could be blended to be within specification, the variation in flow and overall trace component levels would mean that there is a high likelihood that out of specification gas could be generated.

The different systems are considered in the cost:benefit analysis section.

## 4.3 Available Clean up Technologies

There is limited information on commercially available clean-up systems for domestic and commercial equipment. Enquiries with fuel cell manufacturers have provided some supporting information, and the details of the different technologies are considered in the cost:benefit analysis section.

## 4.4 Hydrogen Production Costs

### 4.4.1 Views of stakeholders

A stakeholder engagement exercise was carried out between 24th November 2018 and the 24th January 2019. Industrial and academic stakeholders were consulted to determine their thoughts on the costs associated with producing hydrogen to varying levels of purity.

Stakeholders at the following companies and universities were consulted:

Advanced Plasma Power, Air Liquide, BOC, Costain, H21, Imperial College London, ITM Power, Johnson Matthey, Linde Hydrogen, Progressive Energy, SINTEF, University of Edinburgh and Worcester Bosch.

In order to maintain confidentiality on the topics discussed, the conversations will not be recorded here, but some of the key points noted are summarised below. Additional information found through stakeholder engagement is referenced throughout the report where it is relevant.

Stakeholder thoughts on the potential purity cost trade-off:

- The question of what purity of hydrogen to produce to optimise costs is difficult to answer. Manufacturers of reformers are normally given a specification and will design a reformer to match that.
- The optimum purity will change as new technologies and different applications emerge.

Stakeholder thoughts on methanation:

- Methanation is a simple way to reduce the CO levels to below a few ppm.
- If a PSA isn't used a methanator will provide a CO slip that is well within the HSE limits.
- For a reformer burning H<sub>2</sub> as a fuel for the fired heater, methanation does not offer a cheaper purification option to a PSA.

Stakeholder thoughts on using a PSA:

- Try to avoid using a PSA as this loses up to 10% of the hydrogen produced.
- Producing hydrogen to a lower purity with a PSA could gain roughly only 1-2% in efficiency.
- Reducing or increasing the purity with a PSA gives small costs savings, bigger cost savings are associated with removing the PSA entirely.
- The PSA recovery rate isn't only dependent on purity, it also depends on the quality of the PSA equipment, temperature, pressure and other reformer conditions.

### 4.4.2 Hydrogen Production Routes Considered

#### 4.4.2.1 Tasks 1b and 1c - Production Routes

This report draws on the previous work by Element Energy for Tasks 1b and 1c of Hy4Heat WP2, reporting on hydrogen production methods and purity. In that work, a list of hydrogen production routes to be





considered were outlined, and they are displayed here in Figure 23. For more detail about these production routes view the Task 1b and 1c report.

Three routes involving methane reforming, either an autothermal reformer (ATR) or steam methane reformer (SMR), to produce hydrogen are considered here. Route (A) consists of a reformer, followed by the standard high temperature and low temperature water gas shift reactions (HT + LT WGS) and then carbon capture using an amine wash. This is considered as the 'base reformer' onto which additional purification steps will be added.

In route (B) methanation is used to reduce the levels of carbon oxides after carbon capture and in route (C) a pressure swing adsorber is used to purify hydrogen after carbon capture.

Two routes involving the electrolysis of water, using either alkaline electrolysis (AEL) or polymer electrolyte membrane (PEM) electrolysis, to produce hydrogen will be considered. Route (E) includes a temperature swing adsorber (TSA) to remove water from the product and route (D) with no purification step.

#### **4.4.2.2 Purity cases considered**

##### **Reformer-produced Hydrogen**

In the report for Tasks 1b and 1c, a framework for the cost benefit analysis was outlined. This framework is displayed in Figure 24. This framework was developed to assess costs associated with the levels of each impurity anticipated to be found in the hydrogen produced: carbon monoxide, water, carbon dioxide, methane, inert gases, oxygen and sulphur compounds. Due to the purification steps available, and constraints imposed by the need to transport hydrogen safely, these options can reduce. Table 23 outlines the purity levels considered. This section sets out the justification for the examination of only these purity levels.

### (A) Reformer + WGS + Amine Wash

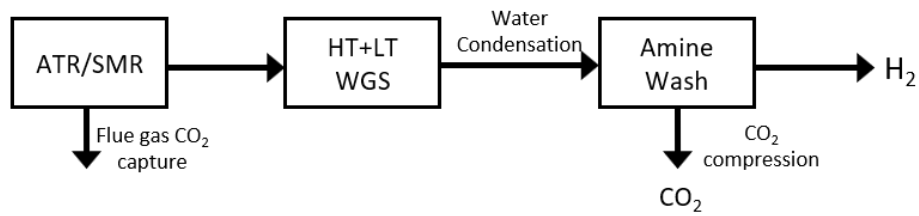

### (B) Reformer + WGS + Amine Wash + Methanation

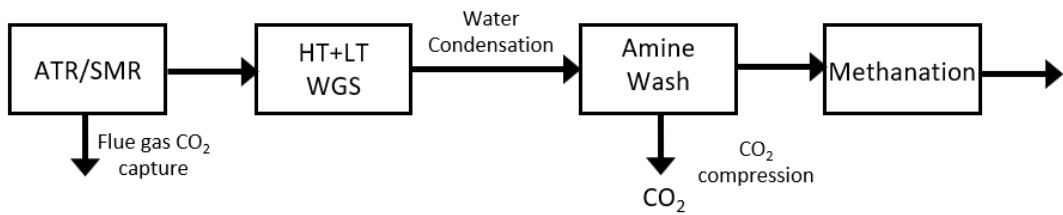

### (C) Reformer +WGS + Amine Wash + PSA

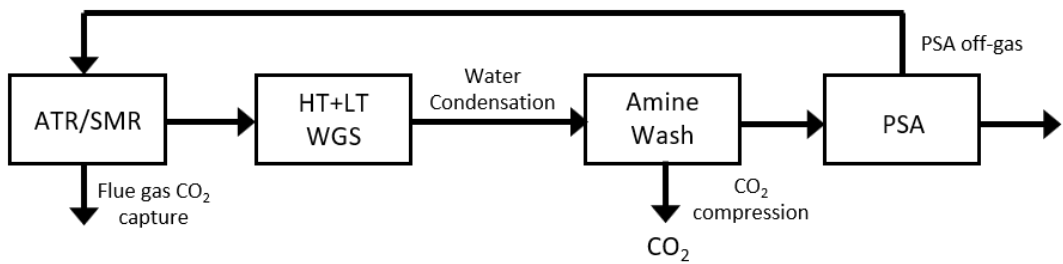

### (D) Electrolysis

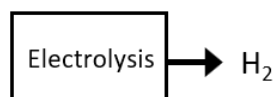

### (E) Electrolysis + TSA

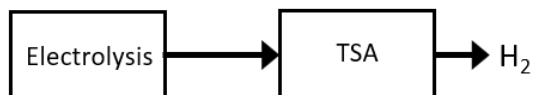

**Figure 22: Purification routes for consideration in the cost benefit analysis**



Impurity Level of Impurity X (ppm)	End Use				Production Route			
	1	2	3	4	A	B	C	D
x	Green	Green	Green	Green	≈	✗	✗	✓
y	Green	Green	Green	Red	✓	✗	✗	✓
z	Green	Green	Green	Red	✓	✗	≈	✓
m	Yellow	Yellow	Yellow	Red	✓	≈	✓	✓
> m	Red	Red	Red	Red	✓	✓	✓	✓

Increasing Impurity ↓

**Key:**

Safety or Damage Issues	No additional Cost	Can produce to this purity	Cannot produce to this purity
Efficiency Trade-Off		Can produce within some of this range	

**Figure 23: Framework proposed in Tasks 1b and 1c for the Cost Benefit Analysis**

The need to transport hydrogen safely requires a maximum limit of 200ppm carbon monoxide (CO), to meet the CO workplace exposure limit [98], and a water dew point limit of -10°C at 85 barg to prevent water condensing in the pipes that transport hydrogen. These limits are discussed in more detail in section 3.4 of this report, which covers sub task 1e of this project.

In this analysis 30 ppm will therefore be considered as the highest level allowable level of water, and 200 ppm as the highest level of carbon monoxide. Production route (A) in Figure 22, has carbon monoxide levels of ~1000 ppm or greater, and so will only be considered as a reference case with no purification in this analysis.

Methanation (Route (B)) only removes carbon monoxide and carbon dioxide, and so is only considered as an option for removing carbon monoxide to a safe level. It is unable reduce carbon oxides to the levels specified in the ISO/DIS 14687 standard for PEM fuel cells [96] used in transport applications (Vehicle PEMFC).

Pressure swing adsorbers (PSAs) on the other hand can remove carbon oxides and all other impurities found in reformer produced hydrogen. A PSA can therefore be used to both remove carbon monoxide and water to safe levels and can be further designed to produce PEM fuel cell standard hydrogen. If a PSA is used, the levels of inert gases, methane, carbon dioxide and sulphur compounds would also be reduced.

Different impurities are adsorbed with different strengths to the PSA adsorbent. Figure 25 demonstrates the different strengths with which impurities adsorb. In removing carbon monoxide, other impurities, especially those that are more strongly adsorbing, will also be removed. A study by Besancon et.al. [45] found that for reformer produced hydrogen, reducing carbon monoxide to the ISO/DIS 14687 standard for PEMFC vehicles also reduced all other impurities, except for nitrogen and argon, to the fuel cell standard.

**RELATIVE STRENGTH OF ADSORPTION**

+	++	+++	++++
<i>He</i>	<i>Ar</i>	<i>CO</i>	<i>C<sub>3</sub>H<sub>6</sub></i>
<i>H<sub>2</sub></i>	<i>O<sub>2</sub></i> <i>N<sub>2</sub></i>	<i>CH<sub>4</sub></i> <i>CO<sub>2</sub></i>	<i>C<sub>4</sub>H<sub>8</sub></i> <i>C<sub>5</sub>+ H<sub>2</sub>S</i>
<div style="display: flex; align-items: center;"> <div style="writing-mode: vertical-rl; transform: rotate(180deg); font-weight: bold; margin-right: 5px;">- Strength +</div> <div style="text-align: center;"> </div> </div> <div style="margin-top: 5px;"> <span style="color: green; font-weight: bold;">Alumina</span>  <span style="color: purple; font-weight: bold;">Carbon Prefilter</span>  <span style="color: green; font-weight: bold;">Activated Carbon</span>  <span style="color: purple; font-weight: bold;">Molecular Sieve</span> </div>		<i>C<sub>2</sub>H<sub>6</sub></i> <i>C<sub>2</sub>H<sub>4</sub></i> <i>C<sub>3</sub>H<sub>8</sub></i>	<i>NH<sub>3</sub></i> <i>H<sub>2</sub>O</i>

**Figure 24: Relative strengths of adsorption to a different PSA adsorbents [45]**

The levels of impurity considered will therefore be framed around the key impurity carbon monoxide. The levels for consideration in this cost benefit analysis are displayed in Table 23. This table also depicts which purification methods are applicable to reach the considered purity level, the other impurities present at each carbon monoxide level and the end uses which those impurities may impact.

**Table 23: Levels of purity considered for the cost benefit analysis, their reason for inclusion and the potential impact on different end uses: Red is unsafe, orange is safe but not usable for solid oxide fuel cells, green is safe but does not meet the ISO/DIS 14687 standard for fuel cell vehicles, blue meets this standard.**

Purification	Impurity Level	Impurities reduced	Ar	N <sub>2</sub>	CO	CO <sub>2</sub>	CH <sub>4</sub>	H <sub>2</sub> S	H <sub>2</sub> O	Reasoning for inclusion
None	No purification	Only CO <sub>2</sub>	Green	Green	Red	Green	Green	Green	Green	UNSAFE CO level. Used as a reference,
Methanation	CO <50 ppm	CO, CO <sub>2</sub>	Green	Green	Green	Green	Orange	Orange	Green	A purification option that has a safe level of CO.
PSA	CO < 250 ppm and other impurities removed	H <sub>2</sub> S, CH <sub>4</sub> , CO <sub>2</sub> , CO, N <sub>2</sub> , Ar	Green	Green	Green	Blue	Blue	Blue	Blue	Closest data point to reaching a safe level (200 ppm) of CO with a PSA.
PSA	CO < 50 ppm	H <sub>2</sub> S, CH <sub>4</sub> , CO <sub>2</sub> , CO, N <sub>2</sub> , Ar	Green	Green	Green	Blue	Blue	Blue	Blue	Examines the potential cost of reducing CO to a 'safer' level using a PSA
PSA	CO < 1 ppm	H <sub>2</sub> S, CH <sub>4</sub> , CO <sub>2</sub> , CO, N <sub>2</sub> , Ar	Green	Green	Green	Blue	Blue	Blue	Blue	Examines the potential cost of reducing CO to a 'safer' level using PSA
PSA	CO <0.2 ppm	H <sub>2</sub> S, CH <sub>4</sub> , CO <sub>2</sub> , CO, N <sub>2</sub> , Ar	Green	Green	Blue	Blue	Blue	Blue	Blue	The two impurities that impact FC catalysts, CO and H <sub>2</sub> S are now reduced to levels specific in the ISO standard.
PSA	CO <0.2 ppm, N <sub>2</sub> <300 ppm	H <sub>2</sub> S, CH <sub>4</sub> , CO <sub>2</sub> , CO, N <sub>2</sub> , Ar	Blue	Blue	Blue	Blue	Blue	Blue	Blue	All impurities produced by an SMR meet the ISO/DIS 14867 vehicle standard
PSA	CO <0.2 ppm, Ar <300 ppm (ATR)	H <sub>2</sub> S, CH <sub>4</sub> , CO <sub>2</sub> , CO, N <sub>2</sub> , Ar	Blue	Blue	Blue	Blue	Blue	Blue	Blue	All impurities produced by an ATR meet the ISO/DIS 14867 vehicle standard

## Certainty in levels of impurity present

For impurities that are removed by a PSA but are not the focus of this study, such as H<sub>2</sub>S, CO<sub>2</sub>, CH<sub>4</sub> and H<sub>2</sub>O, no explicit data has been found on their levels when carbon monoxide is reduced to 250 ppm. It is noted instead that these molecules are strongly adsorbing to the PSA adsorbent, as shown in Figure 25, and so will likely be reduced to lower levels than carbon monoxide is reduced to. These impurities also do not feature in the modelling studies of a PSA by the US Department of Energy (US DoE) [99] and by Besancon et. al. [45], as they are noted to be reduced to low levels.

It is determined later, in this report that at the levels considered here, H<sub>2</sub>S, CO<sub>2</sub> and CH<sub>4</sub> only have a significant impact PEMFC. These impurities are noted to be below the ISO/DIS vehicle PEMFC limits [96] when carbon monoxide meets this standard, and so they do not need to be considered separately.

This study found no definitive data that a PSA designed to remove carbon monoxide to 250 ppm would also remove water to less than 30 ppm. However, it is noted that water is the most strongly adsorbing impurity to the PSA adsorbents and a study for the EMPIR hydrogen project [23] found that a PSA designed to reduce carbon monoxide to 10 ppm, would reduce water to 1 ppm.

## Trace impurities

This project found little data about the trace impurities, such as NH<sub>3</sub>, formaldehyde, formic acid, that may be produced in the reaction chambers and so may be present if the PSA is removed [23]. A discussion with a stakeholder confirmed that most of these are removed in the water that condenses from the syngas, and during the amine wash used to remove carbon dioxide. It is noted that if water is non-condensing at all operating temperatures then these impurities will not impact the corrosion of boilers and cookers. Further if a PSA is introduced to reach a fuel cell standard, these impurities are strongly adsorbing and so are also reduced to the fuel cell standard.

The EMPIR hydrogen project [23] concludes that formic acid and formaldehyde are considered practically impossible to be found in hydrogen purified by a PSA. However, it also notes that the ISO standard for formaldehyde is extremely low. The project therefore assigned a small risk to formaldehyde being present in hydrogen produced by a PSA to the PEMFC standard, due to the lack of analytical data on its presence after a PSA

### 4.4.3 Electrolysis Produced Hydrogen

The standard practice for hydrogen produced by electrolysis is to purify with a de-oxygenation step and a drying step, to reduce oxygen and water to acceptable levels. The EMPIR hydrogen project [23] sampled hydrogen produced by a PEM electrolyser without the presence of a temperature swing adsorber (sometimes called a desiccant drier) and found water levels of greater than 100 ppm. This level would not be compatible with the requirement that water does not condense in the pipes, and so the TSA is required. We therefore will not examine the costs associated with the TSA further here as there is no potential trade off to feed into the draft purity standard.

When a TSA is used, both the EMPIR hydrogen project [23] and HyCORA project [2] found samples that were below the ISO/DIS 14687 standard [8] for vehicle PEMFC.

### 4.4.4 Base Production Costs and Assumptions

#### 4.4.4.1 Types of reformer considered

The types of reformer that could be considered in this report are autothermal reformers (ATR), gas heated reformers (GHR) and steam methane reformers (SMR). A gas heated reformer is the addition of an SMR to



an ATR flowsheet, in order to make better use of heat produced in the process, and so it isn't considered as a separate case here.

Within each of these types of reformers a fired heater is used to provide heat for the reaction chamber, generating steam and/or pre-heating the feedstock. This fired heater can use either some of the hydrogen product, the natural gas feedstock or a mixture of the two as a fuel.

The choice of this fuel is dependent upon the targeted carbon emissions savings. If hydrogen is used as the fired heater fuel, all the scope 1 carbon emissions are found in the syngas of the reformer where carbon can be captured at high pressure (HP CC). If on the other hand natural gas is combusted in the fired heater, carbon dioxide is produced and must be captured at low pressure (LP CC).

According to the H21 North of England report [100] HP CC requires 25% of the energy required LP CC. The report also notes that LP CC can capture up to 90% of the carbon dioxide present at the point of capture, and HP CC can capture up to 99.8% of carbon dioxide present in the syngas. Therefore, the lower the amount of natural gas combusted as a fuel, where LP CC can only capture 90% of the emissions, the higher the carbon emission reductions achievable.

In an ATR, almost all of the carbon dioxide is produced at high pressure in the reformer, and so can be captured using high pressure carbon capture. Here, hydrogen or natural gas or a mix of the two could be used as a fuel for the fired heater. In an SMR, the amount of gas combusted in the fired heater is significantly higher than for an ATR, and so it would not be economical to use only hydrogen as a fuel for the fired heater.

In this report we will consider an ATR using hydrogen as a fuel, an ATR using natural gas as a fuel and an SMR using natural gas as fuel, in order to examine the potential range of impacts that purification steps might have on the cost of hydrogen.

#### **4.4.4.2 Value of hydrogen product**

Throughout this report we will consider the higher heating value of combustion (HHV) of the hydrogen product when considering the energy value of the hydrogen. This assumes that the latent heat of vaporisation of water is recovered as useful heat, as is the case in condensing boilers. The HHV is used for all end-uses for consistency.

In considering hydrogen containing impurities that can combust, such as methane, then the calorific value of the hydrogen with impurities will be higher than that of hydrogen alone. For example, a gas with 0.2 mol% CO, 0.3 mol% methane and 97.5 mol% H<sub>2</sub> releases 1.01 MJ of energy for every MJ of H<sub>2</sub> (HHV) combusted. Higher levels of impurities increase this value.

For applications where hydrogen is combusted, such as boilers and cookers, this additional energy is valuable for the end user and we state the cost of hydrogen in pence per kilowatt hour of the total calorific value. This will be referred to as the levelized cost of energy (LCOE) throughout this report. The carbon emissions that arise from burning carbon-containing impurities are clearly stated, and a cost of carbon is included in the cost-benefit analysis to account for this.

For fuel cell applications, the impurities are not used, and so the cost of hydrogen is stated in p/kWh of hydrogen only. This will be referred to as the levelized cost of hydrogen (LCOH) throughout this report.

#### **4.4.4.3 Hydrogen production parameters**

##### **Data Source**

The costs associated with an ATR and an SMR are taken from the ATR and SMR modelled in the H21 North of England report. [100] This source is used as it is the most recent source of a reformer designed to produce of hydrogen for heat, and it contains data of reformers designed for scales applicable for the Hy4Heat

programme. This report also has the benefit of including detailed information about the breakdown of the costs. Here we use the data from SMR option 2: SMR with both syngas high pressure CO<sub>2</sub> capture and low pressure CO<sub>2</sub> capture and ATR option 2: Oxygen fired ATR with Gas Heated Reformer (GHR) and syngas high pressure CO<sub>2</sub> capture.

The H21 NoE report includes the costs of carbon capture and storage and hydrogen storage associated with a 12.15 GW facility (made up of several reformers), meeting an annual demand of 74.5 TWh pa. Here these values will also be included but scaled linearly to match the annual production of a 1.5 GW individual reformer, running for the same number of hours per year to produce 9.2 TWh pa. For the equivalent SMR, the amount of CO<sub>2</sub> captured differs from that of the ATR, and so the CO<sub>2</sub> T&S costs are also scaled to amount of CO<sub>2</sub> captured annually.

The data taken from the report is presented in Table 24. The amount of hydrogen and natural gas used to feed the fired heater are calculated using the carbon flows on pages 111 and 115 of the H21 report.

For the analysis here only the scope 1 emissions, due to carbon dioxide emitted directly in the syngas, by the fired heater and when the impurities in the syngas are combusted, are included. The H21 study reported estimates of both scope 1,2 and 3 emissions for the ATR reformer selected. They found scope 2 emissions, which also include the emissions due to the electricity used by the reformer, added 0.073 g CO<sub>2</sub>/kWh H<sub>2</sub> and the scope 3 emissions, including the emissions associated with the production and transport of the natural gas feed, added 35.2 g CO<sub>2</sub>/kWh H<sub>2</sub>.

Information	ATR	SMR
Production Capacity (MW) <sup>1</sup>	1500	1500
CO <sub>2</sub> Emissions (g/kWh)	13.1	20.5
CO <sub>2</sub> Capture (t/h)	315	312
Total NG consumption (MW)	1805	1850
Electricity consumption (MW)	72.6	35.6
NG fuel in fired heater (MW)	40	661
H <sub>2</sub> fuel in fired heater (MW)	167	0
Reformer Capex (£m)	947	1082
CO <sub>2</sub> T&S (£m capex)	145	144
H <sub>2</sub> Storage (£m capex)	223	223

**Table 24: Hydrogen production information from the H21 NoE report (Source: [100])**

### Reformer Options Considered

Hydrogen or natural gas (or a mixture of both) can be combusted to provide heat for the process; generating steam or pre-heating the feedstock. The impact that the use of either a PSA, or of methanation, has on the cost of production is dependent upon this choice.

In order to consider the most extreme cases, an ATR burning only hydrogen to generate heat and an ATR burning only natural gas are developed using the H21 data and our own calculations. In these calculations, the reformer is assumed to remain constant, and the hydrogen product and natural gas combusted in the

<sup>1</sup> Note that this value is the 'H<sub>2</sub> production', rather than the combined calorific value of the product gas and impurities.



fired heater are interchanged. Figure 25 and Figure 26 display the energy flows for these updated reformers. Figure 27 then displays equivalent diagrams for the SMR considered in this report. The energy consumptions, capital costs and CO<sub>2</sub> emissions for these cases are displayed in Table 25.

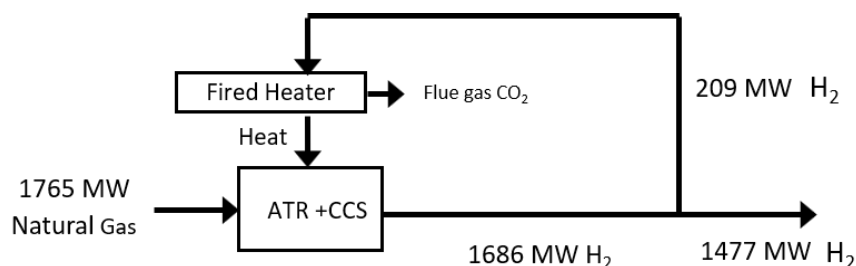

**Figure 25: Natural gas and hydrogen flows for an ATR using hydrogen as a fired heater fuel.**

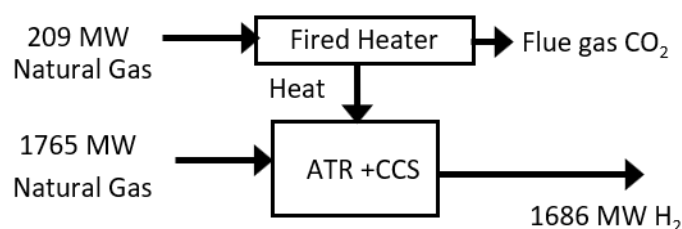

**Figure 26: Natural gas and hydrogen flows for an ATR using natural gas as a fired heater fuel.**

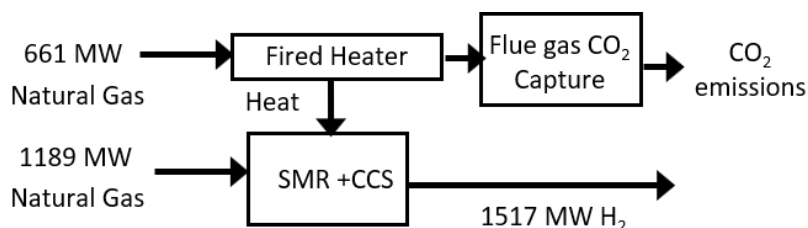

**Figure 27: Natural gas and hydrogen flows for an SMR.**

Information	ATR		SMR
Fired heater Fuel	H <sub>2</sub>	CH <sub>4</sub>	CH <sub>4</sub>
Production Capacity (MW) <sup>1</sup>	1460	1667	1500
CO <sub>2</sub> Emissions (g/kWh)	8.2	30.2 <sup>2</sup>	20.5
Total NG consumption (MW)	1765	1974	1850
Electricity consumption (MW)	72.6	72.6	35.6
Reformer Capex (£m)	947	947	1082
CO <sub>2</sub> T&S (£m capex)	201	201	185
NG fuel in fired heater (MW)	0	209	595
H <sub>2</sub> fuel in fired heater (MW)	207 <sup>3</sup>	0	0

**Table 25: Hydrogen production information for each of the reformers considered**

<sup>1</sup> Note that this value is the H<sub>2</sub> HHV, rather than the calorific value including the impurities.

<sup>2</sup> We assume no carbon capture from the fired heater flue gas in this case.

<sup>3</sup> Hydrogen HHV, calorific value would be 209 MW

## Levelised cost of hydrogen without purification

The cost assumptions used in this report are displayed in Table 26. The natural gas cost, 63 p/therm, is the central scenario of the BEIS 2018 Fossil Fuel Price Assumptions for 2035 [101], published in November 2018. The 2035 wholesale prices for electricity and carbon emission costs for industry and services are assumed from Annex M of the BEIS Updated energy and emissions projections (2017). [102]

The use of the wholesale electricity price assumes the generation of electricity on site, consistent with the reformers in the H21 report [100] and the IEA models of an SMR with carbon capture [14]. The reformer lifetime of 25 years used in the H21 models [100] and IEA modelling of SMRs with carbon capture [14] is assumed. The load factor is assumed to be the same as those of the H21 reformers, which have a capacity (12.15 GW) and annual demand (74.5 TWh). A construction time of 3 years with 20% of the capital expenditure in the first year, and 45% and 35% in the second and third years of construction are assumed, in line with the assumptions in the IEA study [103].

Variable	Wholesale
Discount rate	3.5 %
Cost of natural gas (£/MWh)	21.5
Cost of electricity (£/MWh)	46
CO <sub>2</sub> Emission Cost (£/tonne)	39.4
Lifetime of Reformer (years)	25
Load factor	70 %
Opex as % of Capex	3%
Reformer Construction time (years)	3

**Table 26: Operating cost assumptions**

The levelised cost of hydrogen is then calculated using the discount rate of 3.5% for projects or policies that have long term effects, recommended by the Green Book – Central Government Guidance on Appraisal and Evaluation [104]. In this analysis we have assumed that there is no cost of capital. The calculated LCOE and LCOH without purification are outlined in Table 27. These numbers are lower than the 5 p/kWh calculated in the H21 case, due to the lower discount rate, cost of electricity and CO<sub>2</sub> emission cost assumed here.

Reformer:	ATR		SMR
Fired heater Fuel	H <sub>2</sub>	CH <sub>4</sub>	CH <sub>4</sub>
LCOE (p/kWh energy)	4.18	4.02	4.26
LCOH (p/kWh H <sub>2</sub> HHV)	4.23	4.06	4.31

**Table 27: Levelised cost of hydrogen (LCOH) with no purification steps**

Figure 28 shows the breakdown of the LCOE between capital and operating costs, for the ATR using hydrogen as a fired heater fuel.

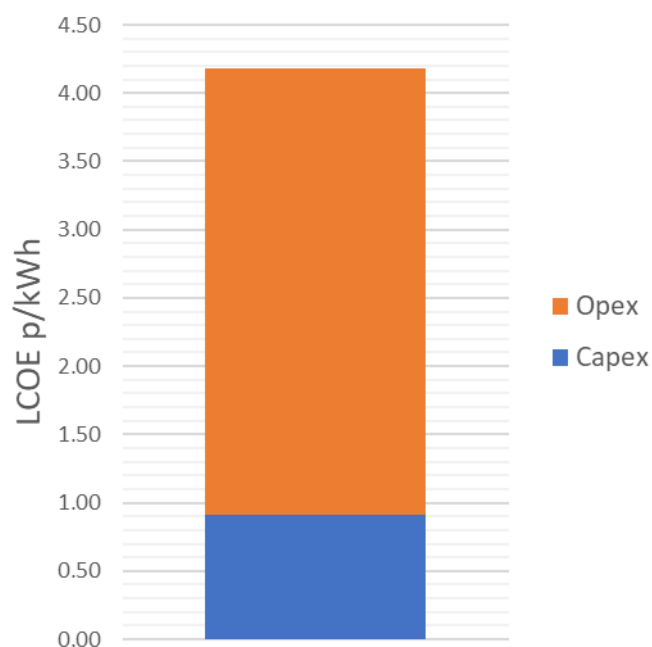

**Figure 28: Breakdown of the contributions of the reformer capital cost and operating costs to the LCOE of hydrogen produced by an ATR, using hydrogen as the fired heater fuel and with no purification.**

#### Assumed syngas

The ranges of impurities found in literature data for an oxygen-fed ATR and SMR are summarised in the Table 28. The choice of fired heater fuel does not impact the product purity. For both the ATR and the SMR we assume carbon is captured from the syngas at high pressure, using the capture rate of 98% assumed by Linde [105]. This gives the CO<sub>2</sub> levels outlined in Table 29.

Molecules	SMR (dry mol%)	Oxygen-Fed ATR (dry mol %)
H <sub>2</sub>	70-80	72
CO	0.1-3	0.2-1.4
CO <sub>2</sub>	15-25	27
CH <sub>4</sub>	3-6	0.2-2.4
N <sub>2</sub>	0-0.2	0.7 <sup>1</sup>
Ar	0	0.6 <sup>1</sup>
Sources	[17],[18],[4]	[19][20]

**Table 28: Literature values for syngas compositions after the water gas shift reaction**

<sup>1</sup> These values are taken from a syngas composition after carbon capture.

Molecules	SMR (dry mol%)	Oxygen-Fed ATR (dry mol %)
CO <sub>2</sub>	0.35-0.66	0.73

**Table 29: Calculated CO<sub>2</sub> levels after carbon capture at high pressure using an amine wash**

The next section outlines the impact that the selected purification steps have on the levelised cost of hydrogen. For a more detailed description of each technology and the associated costs, please read section 3.2 of this report covering sub tasks 1b and 1c. The impact of each technology is calculated by keeping the inputs into the reformer fixed at the values described in Table 25 constant and considering the impact of the purification step on the output hydrogen and the fired heater requirements.

#### 4.4.5 PSA Purification

##### 4.4.5.1 Impact of PSA on the reformers considered

###### Impact: Hydrogen fired heater case

If a PSA is added to a flowsheet where hydrogen is combusted to provide heat to a reformer, the PSA tail gas displaces hydrogen product that would have otherwise been combusted. The tail gas provides more energy per molecule of hydrogen when combusted than the hydrogen product, due to the higher fraction of combustible components (methane, CO) present in the tail gas. The hydrogen production is therefore marginally increased, as less hydrogen is combusted in the product, while the energy content of the product remains unchanged. The impact of the PSA on the cost of hydrogen is therefore largely due to the capital cost of the PSA in this case.

This changes if the amount of energy present in the PSA tail gas is higher than the energy demand of the fired heater providing heat for the process. In this case the model used here assumes that the excess tail gas is vented, causing a reduction in the hydrogen product. In an industrial reformer it is unlikely that any energy would be wasted by venting the tail gas. Instead we expect that the process would be re-designed to make use of this energy, for example through additional feed pre-heating or generating additional steam, to increase the conversion of methane to hydrogen in the reformer. This model therefore provides an upper bound of the costs of purification in this case, and these cases will be avoided wherever possible.

Example numbers for cases with no tail gas energy wastage and with tail gas wastage are displayed in Figure 29 and Figure 30 respectively.

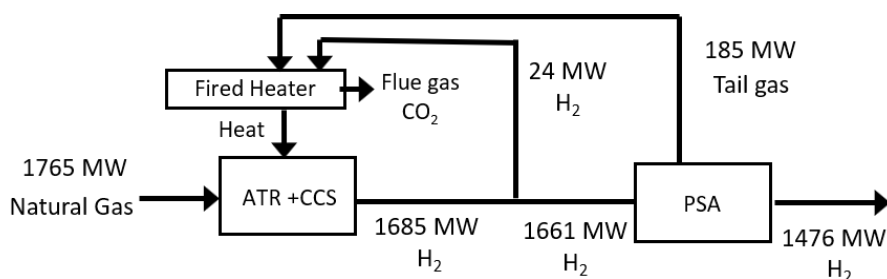

**Figure 29: Example gas flows for an ATR using hydrogen as a fuel for the fired heater and a PSA for purification, when the energy content of the tail gas is less than the fired heater demand.<sup>1</sup>**

<sup>1</sup> All figure values are quoted as the total energy content of the gases present, including impurities.

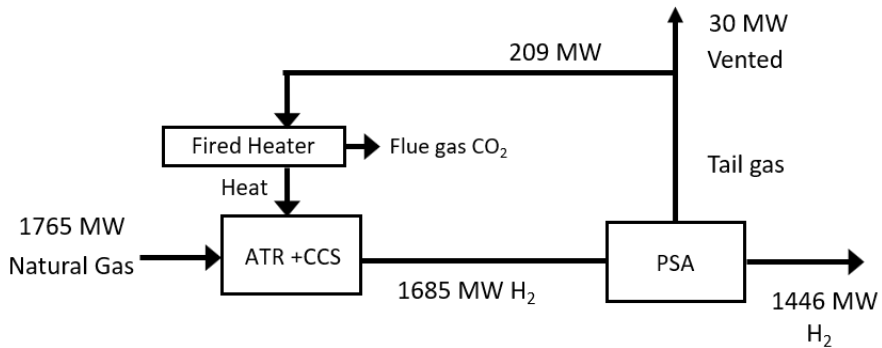

**Figure 30: Example gas flows for an ATR using natural gas as a fuel for the fired heater and a PSA for purification, when the energy content of the tail gas is greater than the fired heater demand.**

The updated hydrogen product for a given targeted purity is calculated as follows:

First the energy in the tail gas and amount of hydrogen recycled to the burner are calculated, using the PSA hydrogen loss in the tail gas for the given purity. The PSA tail gas energy value is then subtracted from the energy of the hydrogen gas entering the PSA to calculate the hydrogen output. The CO<sub>2</sub> emissions in g/kWh are re-calculated for the new hydrogen product.

The amount of CO<sub>2</sub> emitted per kilowatt hour of natural gas input is unchanged by the addition of PSA. The emissions due to the carbon monoxide, carbon dioxide and methane that would have been present in the hydrogen product and would have been emitted at the point of use are instead emitted by the fired heater. However, due to the reduction in the amount of hydrogen produced, the CO<sub>2</sub> emissions per kilowatt hour of hydrogen increase slightly and so are recalculated.

**Impact: Natural gas fired heater case**

If a PSA is added to a flowsheet that uses natural gas as a fuel for the fired heater, in both the SMR and ATR examined, then the PSA tail gas displaces the natural gas fuel that would otherwise be used in the fired heater. The impact on the ATR using natural gas as the fired heater fuel and SMR, examined for this study, are displayed in Figure 31 and Figure 32 respectively.

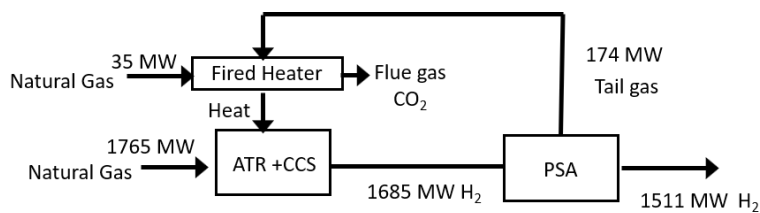

**Figure 31: Impact of a PSA on an ATR using natural gas as a fuel for the fired heater**

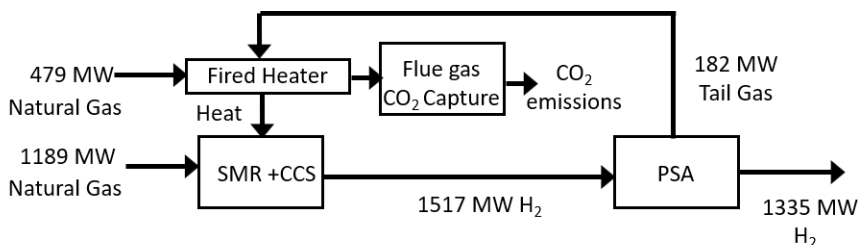

**Figure 32: Impact of a PSA on an SMR**



The loss of hydrogen in the tail gas for a given target purity is used to recalculate the hydrogen product, and the natural gas demand is reduced by the amount of gas displaced by the tail gas. The carbon emissions are re-calculated: The CO<sub>2</sub> emissions that would have been emitted by the natural gas displaced by the PSA tail gas are calculated, and then subtracted from the total CO<sub>2</sub> emissions. For the SMR, 90% of the emissions from the displaced natural gas would have been captured, and so the subtracted value is scaled by 90%. The CO<sub>2</sub> emissions in g/kWh are re-calculated for the new hydrogen product.

A further reduction in CO<sub>2</sub> emissions would also be caused by the 90% capture of the impurities now present in the combusted tail gas, that would have been present in the product. Using the CO<sub>2</sub> emissions of 8.2 g/kWh, that are emitted by the ATR burning hydrogen, due to the impurities in the syngas, this gives an emissions saving of 7.4 g/kWh. Using the assumed carbon cost of £39.4 per tonne, this gives a small cost saving of 0.03 p/kWh. This is not considered in this model.

#### 4.4.5.2 Reference data

The two key costs associated with utilising a PSA for hydrogen purification are the capital costs of the PSA and the amount hydrogen product lost in the tail gas. The costs determined for this in the Tasks 1b and 1c report on hydrogen purity for this project are summarised in this section, followed by the impact that varying the target hydrogen purity has on these parameters.

##### Capital Cost

The H21 NoE report [100] notes a budget quote of £122 million for a PSA with an input of 1.11 GW H<sub>2</sub> and output of 1 GW. This amounts to the PSA making up 11% of the combined cost of the reformer and PSA, if it is assumed that the capital costs of the PSA with 1 GW output and 1.5 GW are the same. If instead the PSA capital cost is assumed to scale linearly with output, then the PSA makes up 15 % of the combined reformer and PSA cost. In contrast, a discussion with a stakeholder at a company that designs reformers noted the cost of the PSA to be in the upper single digit figures as a percentage of the reformer cost. This we assume to be 8-10% of the reformer cost.

The value of 10% of the reformer cost will be used as the reference value for the cost of a PSA used in hydrogen production. The capital cost of the PSA will then be varied between 8 and 15 % of the cost of the reformer and PSA, in order to find the range of plausible cost values. The costs of the reformer quoted in Table 24 and Table 25 will be kept constant.

##### Recovery Rate

The PSA modelling study by Besancon et. al. [45] has a recovery rate of 89 % at 250 ppm of carbon monoxide. A review of PSA technology by Sircar et. al. [110] notes H<sub>2</sub> recovery rates of between 80 and 93% for PSA plants. A stakeholder at an industrial hydrogen producer noted recovery rates of 85-90%, with the potential to improve the recovery rate by only a few percentage points at increased carbon monoxide levels. A PSA expert noted that industrial PSAs typically have recovery rates of 90%, with the potential to improve this using more PSA beds. The H21 NoE report [100] also notes a 10% hydrogen loss in the tail gas of the PSA.

The value of the assumed recovery rate has the potential to have a big impact on the additional costs of hydrogen production associated with increasing levels of purity, as it determines the point at which hydrogen starts to be vented. Therefore, an analysis of the sensitivity to the assumed recovery rate (or hydrogen loss) at 250 ppm CO will be carried out initially before selecting an appropriate value.

##### Variation with Target Purity

Besancon et. al. [45] and the US Department of Energy [111] [99] have modelled the impact of varying targeted hydrogen purity on parameters of the reformer and the PSA. In the US DoE study, a small-scale

reformer and PSA on the forecourt of a refuelling station was modelled. The targeted purity was varied by changing process parameters, such as the steam to carbon (S/C) and pressure are varied, which will also impact the reformation reaction itself.

In the study by Besancon et. al., a PSA used in an industrial reformer is modelled, and the impurity concentration (and hydrogen loss) is varied by changing the PSA adsorbent volume. The study presents graphs of data showing the variation in the levels of specific target impurities with the adsorbent volume and the recovery rate, for the sampled output of a coal gasifier, an ATR and an SMR. The data taken from this study is displayed in Table 30. In the graph in this study, CO levels of <1 ppm are not distinguishable, and so it is assumed the adjacent data point to 1.1 ppm is <0.2 ppm.

In this cost benefit analysis, we do not have data that reflects the impact that varying process parameters will have on the costs of a reformer, and so we will use the data from the study by Besancon et. al. to inform the costs associated with using a PSA to purify to increasing purities.

CO Level (ppm)	Ar Level (ppm) ATR only	N <sub>2</sub> Level (ppm)	Recovery Rate Decrease (% point)	Adsorbent Volume (m <sup>3</sup> )	% increase in PSA capital cost
>1000	6000	7000	No PSA	No PSA	N/A
250	3600	880	0.0	13.60	0.0
50	< 3600	790	0.5	14.30	5.1
1	< 3600	700	1.3	15.00	10.3
<0.2	< 3600	590	1.6	15.3	12.5
<0.2	n/a	300	2.1	15.8	16.2
<0.2	300	<300	9.7	27.5	102.2

**Table 30: Summary of modelled PSA data in the study by Besancon et. al. [45]**

The two key capital costs of a PSA were noted by a stakeholder to be the cost of the adsorbent beds and the cost of the valves. One way to increase the adsorbent volume is to add more PSA beds. For this study we assume that the number of valves would also increase linearly with the number of PSA beds and so the capital cost of the PSA is assumed to scale linearly with the adsorbent volume taken from the Besancon et. al. study.

An alternative approach to increasing the adsorbent volume is to increase the size of the PSA beds. If this is the case, the number of valves would not increase and so the assumed linear scaling of PSA capital cost with adsorbent volume provides an overestimate of the increase of the PSA capital cost. However, a stakeholder with expertise in PSAs noted that PSA bed sizes are usually standardised in industry, and so adding more PSA beds is the more likely route to increasing the adsorbent volume.

It is worth noting that the data taken from the study by Besancon et. al is based upon two syngas samples, one from an SMR and one from an ATR. The SMR data displays the modelled carbon monoxide and nitrogen data and the ATR graph displays data on the removal of argon. For the SMR a syngas with 0.1% carbon monoxide is modelled, which is at the lower limit of carbon monoxide levels achievable with a water gas shift reaction. The same adsorbent volumes for removing carbon monoxide are assumed to be required for the ATR, as a stakeholder noted that the water gas shift reaction should be able to reach similar levels of carbon monoxide for an ATR as for an SMR.

### 4.4.5.3 Purity impact on LCOE

When a PSA is used to reduce the carbon monoxide levels to 250 ppm, the methane levels are also reduced. The reduced levels of combustible impurities in the hydrogen product cause the difference between the LCOH and LCOE for PSA purified hydrogen to be insignificant and so only the LCOE will be presented throughout this section.

In Section 4.4.5.2 we noted that the assumed hydrogen loss in the PSA tail gas at 250 ppm is important when considering the impact of the PSA on the reformers examined. In this model, we calculate the hydrogen loss for any given purity by adding the percentage point increase in hydrogen loss found by the Besancon et. al [45] to reach that purity, to the hydrogen loss assumed at 250 ppm. A higher hydrogen loss at 250 ppm therefore means that, in this model, hydrogen will be wasted for higher levels of purity, and hence a larger additional cost will be associated with these levels. This is particularly important for the ATR modelled, where the energy demand of the burner is low. For the SMR examined this is not an issue, due to the significantly larger amount of natural gas combusted in the fired heater.

#### Sensitivity to assumed PSA hydrogen loss

In order to examine the impact that the assumed tail gas recovery rate has on the cost of hydrogen, the variation of the heat available by burning the tail gas at each purity level is examined. Table 31 presents this tail gas energy content for the modelled ATR at each purity level examined and for assumed hydrogen losses to reach 250 ppm CO of between 7% and 15%. The fired heat energy demand for the ATR and SMR considered in this report are also included for reference. Points at which the tail gas energy exceeds the fired heater demand are highlighted in red.

Assumed hydrogen loss at 250 ppm		7%	9%	10%	15%
CO Level (ppm)	Inert Level (ppm)	Tail Gas Heat (MW)			
250	3600	135	168	185	268
50	< 3600	143	177	193	277
1	< 3600	157	190	207	290
0.2	< 3600	162	195	212	295
<0.2	300 (N <sub>2</sub> )	170	203	220	303
<0.2	300 (Ar)	297	330	347	430
Fired heater Demand (MW)		ATR: 209 SMR: 661			

**Table 31: Heat generated by burning the tail gas produced at each targeted purity level and for assumed hydrogen losses at 250 ppm of between 7 and 15 %**

For assumed hydrogen recovery losses of 7 and 9% at 250 ppm CO, the fired heater demand is greater than the tail gas heat for all the hydrogen purities considered, apart from reducing argon to 300 ppm. At an assumed hydrogen loss of 10% at 250 ppm CO, the tail gas heat is greater than the fired heater demand when reducing CO to 0.2 ppm.



Industrially, instead of wasting the tail gas energy, the process would likely be re-designed in order to make increase the fired heater demand, either by generating more steam or in additional feed gas pre-heating. The calculated LCOE for hydrogen produced when tail gas energy is wasted is therefore likely to be an overestimate, and these cases will be avoided where possible.

This issue is avoided for all purity levels, except for 300 ppm Ar, by assuming a PSA hydrogen loss of 9% at a purity of 250 ppm CO as the central assumption of hydrogen loss for this report. The additional costs associated with increasing purity using a PSA with this assumed hydrogen loss, are displayed in Figure 33.

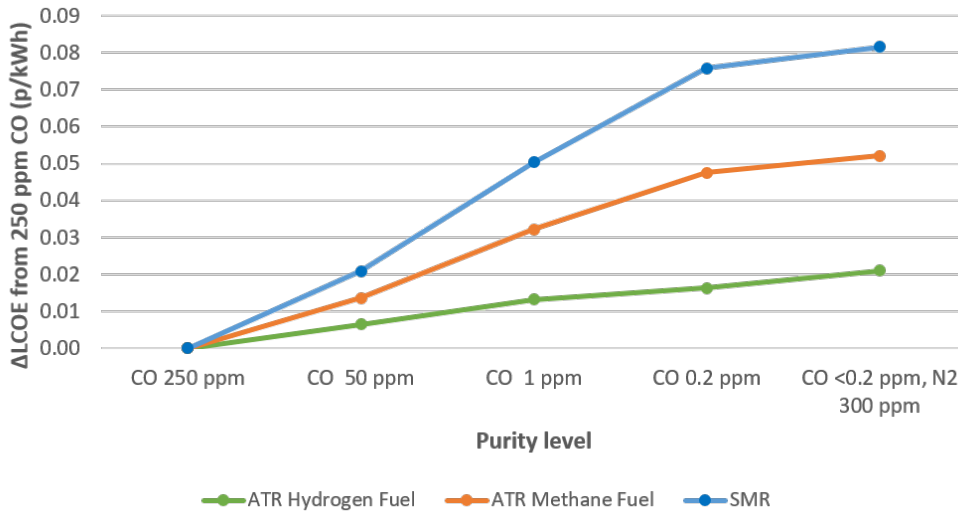

**Figure 33: Additional LCOE for increasing levels of purity beyond 250 ppm CO with a PSA, with an assumed hydrogen loss of 9% and a PSA capex of 10% of the reformer capex, at 250 ppm CO**

In Section 4.4.5.2, hydrogen losses of 7-20% were noted for industrial PSAs, which typically reduce carbon monoxide to lower than 250 ppm. For example, BOC produce hydrogen with total carbons < 10 ppm [112]. Therefore, the lower end of the 7-20% range would be anticipated. A stakeholder also noted that a couple of percentage points reduction in hydrogen loss could be achieved by reducing the hydrogen purity specification. A 9% PSA hydrogen loss at 250 ppm CO is therefore a plausible value.

To examine the sensitivity of the LCOE to the assumed PSA hydrogen loss at 250 ppm CO, the hydrogen loss is varied from 9 to 5 %. Figure 35 displays the impact that this sensitivity has on the costs of reaching increasing purities. In varying the assumed hydrogen loss within this range, the fired heater demand is higher than the tail gas energy for all purities, except for Ar. This sensitivity analysis therefore avoids the potential issue of tail gas wastage. It is assumed that varying the assumed PSA hydrogen loss at 250 ppm from 9% to 5%, will have the same magnitude of impact on the LCOE with increasing purity as varying the assumed PSA hydrogen loss from 9-14% if no tail gas were to be wasted.

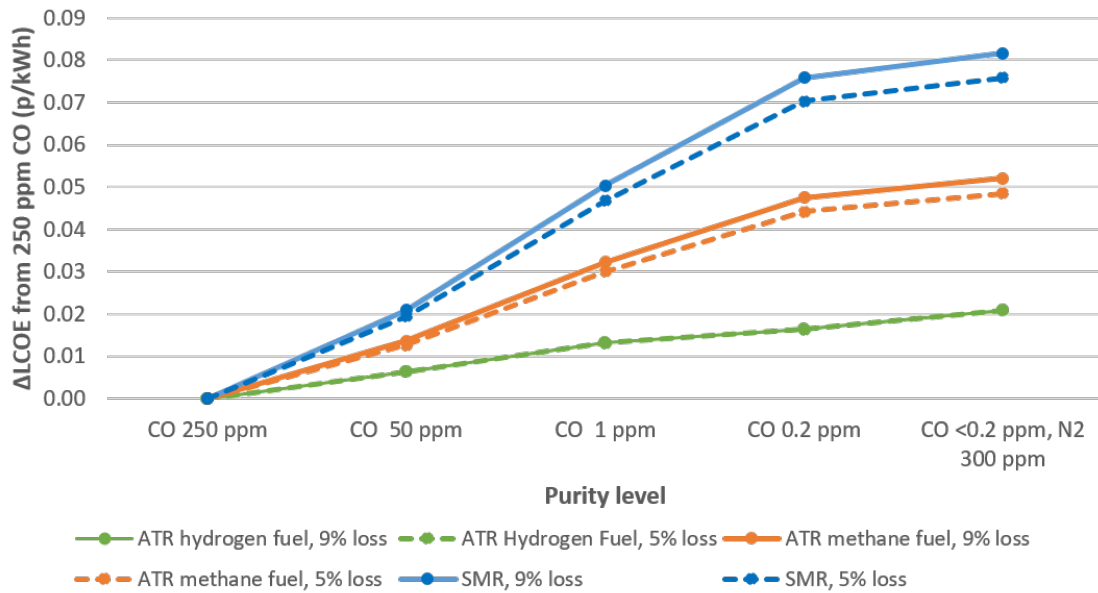

**Figure 34: Impact of varying the assumed PSA hydrogen loss at 250 ppm on the additional LCOE associated with purifying beyond 250 ppm CO**

#### Sensitivity to assumed PSA capital cost

In the model used for this report, the capital cost associated with each purity level is calculated using the percentage increase in capital cost compared to a PSA purifying to 250 ppm CO, displayed in Table 32 and an assumed capital cost for the PSA at 250 ppm CO for which a range of values is given in Section 4.4.5.2. The assumed PSA capex at 250 ppm CO will therefore impact the additional LCOE with increasing purity.

The impact of assuming PSA capital costs of 8%, 10% and 15% of the total capital cost of the reformer, on the additional costs associated with increasing levels of hydrogen purity are displayed in Table 32 and in Figure 35, Figure 36 and Figure 37 for an ATR with a hydrogen fired heater, methane fired heater and an SMR respectively.

Assumed PSA Capex:	Δ LCOE (p/(kWh))								
	ATR H <sub>2</sub> Fired heater			ATR CH <sub>4</sub> Fired heater			SMR CH <sub>4</sub> Fired heater		
	8%	10%	15%	8%	10%	15%	8%	10%	15%
<b>Purity Level</b>									
CO 250ppm	-0.08	-0.11	-0.17	-0.21	-0.23	-0.29	-0.33	-0.36	-0.44
CO 50 ppm	0.000	0.00	0.00	0.00	0.00	0.00	0.00	0.00	0.00
CO 1pmm	0.005	0.01	0.01	0.01	0.01	0.02	0.02	0.02	0.03
CO 0.2 ppm	0.010	0.01	0.02	0.03	0.03	0.04	0.05	0.05	0.06
CO <0.2 ppm, N <sub>2</sub> 300ppm	0.013	0.02	0.03	0.04	0.05	0.06	0.07	0.08	0.09
CO <0.2 ppm, Ar 300 ppm	0.016	0.02	0.03	0.05	0.05	0.07	0.07	0.08	0.10

**Table 32: Sensitivity of PSA impact on LCOH to assumed PSA capex**

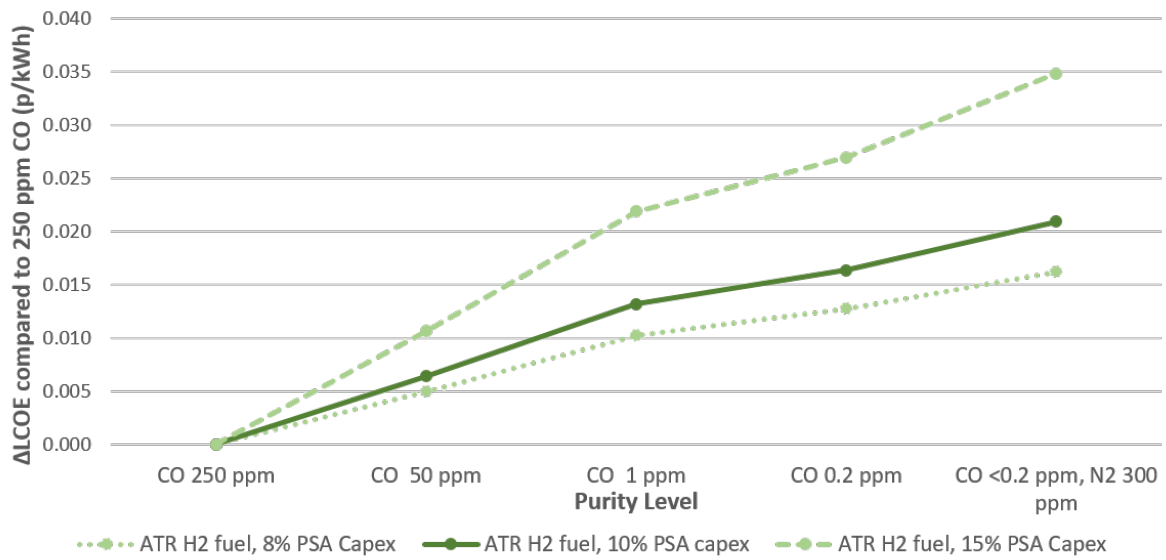

**Figure 35: Sensitivity of PSA impact on LCOE to assumed PSA capex for an ATR using hydrogen as a fuel for the fired heater (CO<sub>2</sub> emissions: 8 g/kWh)**

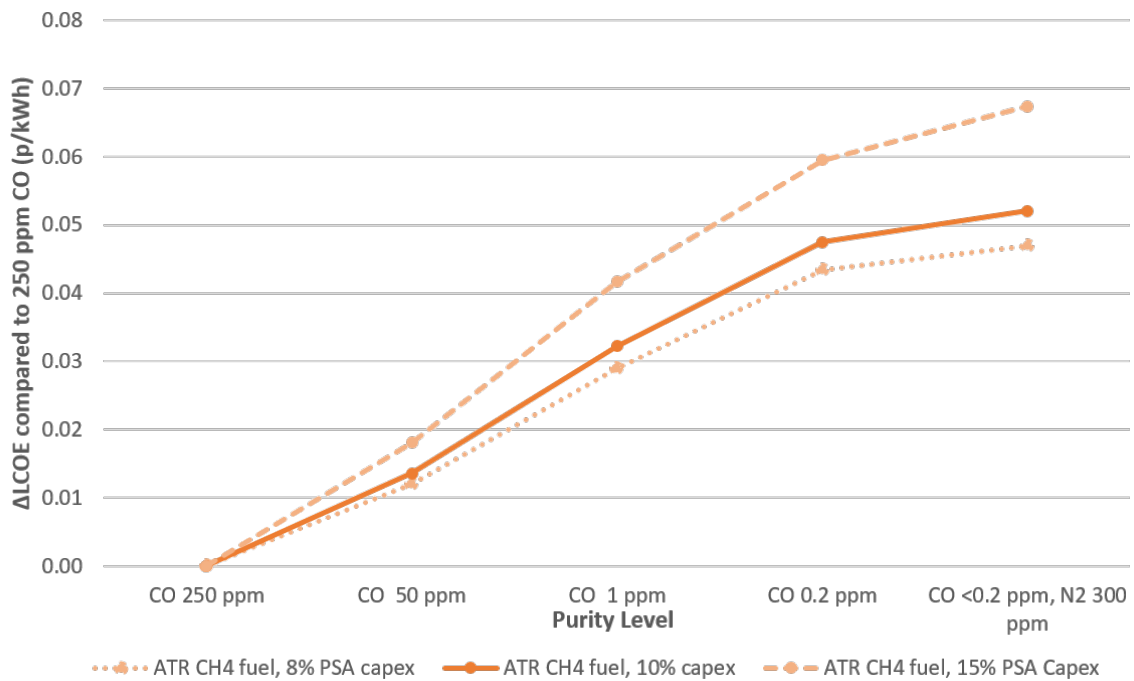

**Figure 36: Sensitivity of PSA impact on LCOE to assumed PSA capex for an ATR using methane as a fuel for the fired heater (CO<sub>2</sub> emissions: 30 g/kWh)**

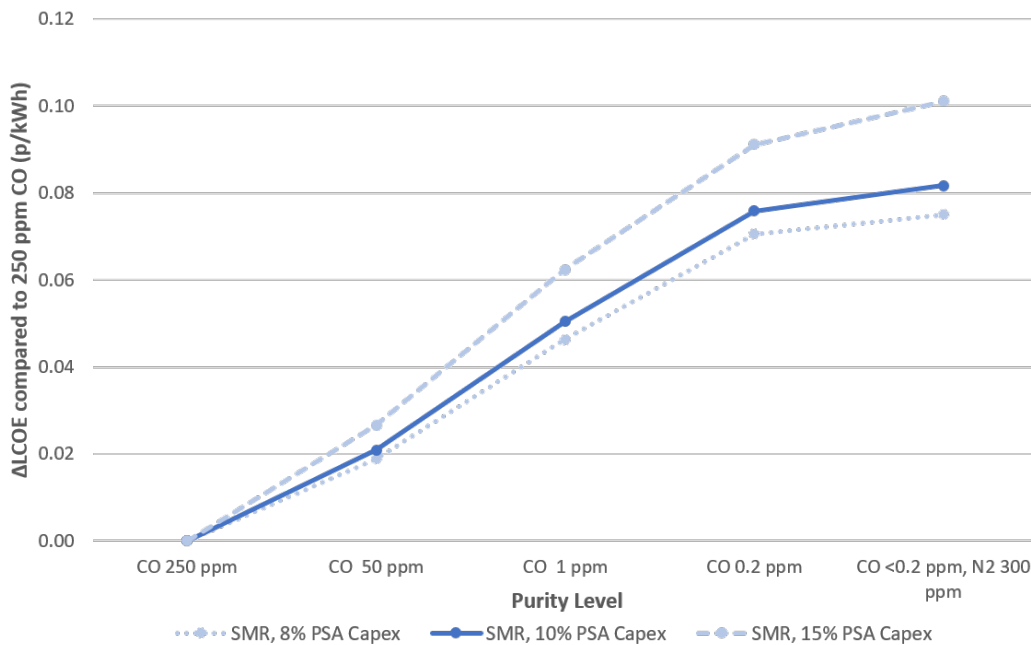

**Figure 37: Sensitivity of PSA impact on LCOE to assumed PSA capex for an SMR (CO<sub>2</sub> emissions: 20 g/kWh)**

**Discussion of results**

The comparative magnitudes of the sensitivities, of the additional LCOE for increasing levels of purity with a PSA, to the assumed PSA capital cost and hydrogen loss at 250 ppm CO are displayed in Figure 38. The sensitivities are compared for the highest purity considered for an SMR, where the range of plausible values is highest. The range of plausible range of values associated with the assumed PSA capex is larger than for the assumed PSA hydrogen loss. We will therefore use this range of plausible values for further analysis.

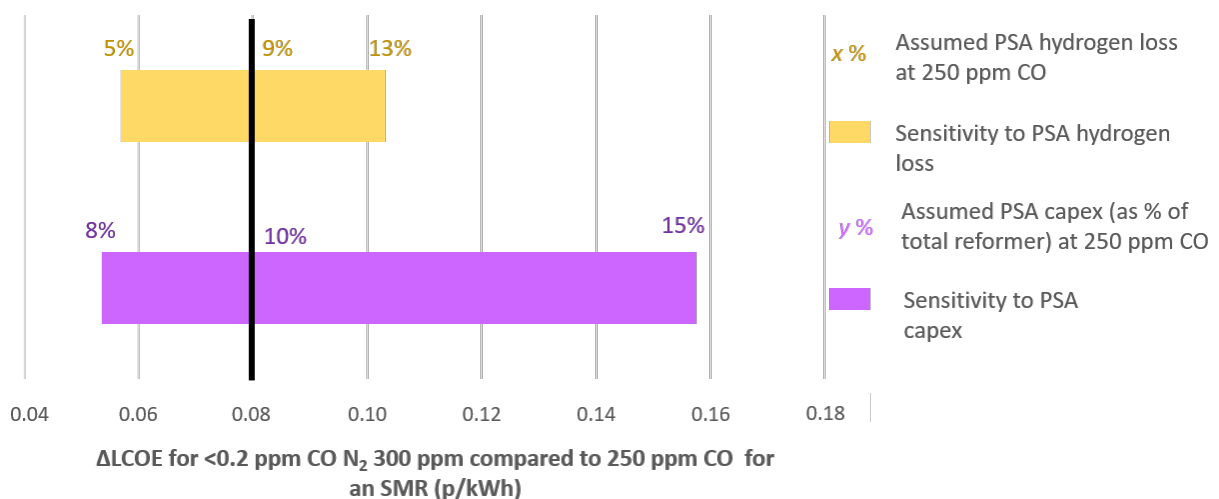
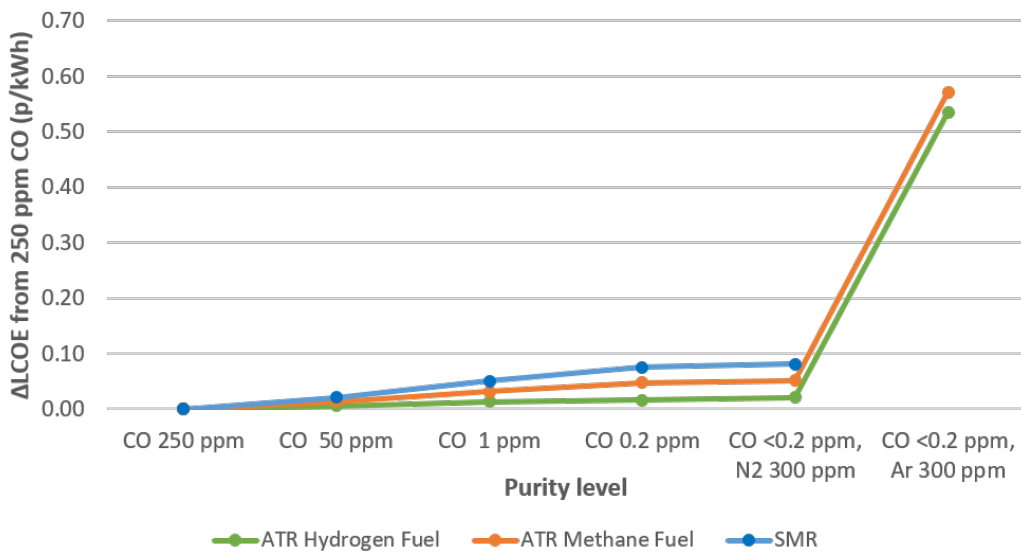

**Figure 38: Comparison of the sensitivity of the additional LCOE to the assumed PSA hydrogen loss, varied between 5 and 13%, and PSA capex, varied between 8 and 15%, at 250 ppm. The impact on a PSA purifying SMR produced hydrogen to <0.2 ppm CO and 300 ppm N<sub>2</sub> is examined.**

Figure 33 demonstrates that the additional costs associated with using a PSA to purify to increasing levels of hydrogen depend upon the type of reformer that the PSA is used alongside. For a reformer using hydrogen as the fired heater fuel, the additional costs of increasing purity are small, while for an SMR the additional costs associated with an increasing purity with a PSA are higher. Each of these reformers considered has different carbon emissions intensity, displayed in Table 37, and so the range of additional production costs associated with hydrogen produced to increasing purities is dependent upon the carbon emissions targeted.

### Argon Removal

Throughout the analysis so far, the additional costs associated with removing argon to the ISO/DIS 14687 standard for vehicle PEMFC have been left off the graphs presented. Figure 39 therefore replicates Figure 44 but with the argon point included. In this model, the costs associated with removing argon with a PSA are significantly higher than those associated with reducing the levels of other impurities. This is due to argon being the most weakly adsorbing, of the impurities present, to the PSA adsorbent materials. Figure 17 shows this.



**Figure 39: Additional LCOE for increasing levels of purity with a PSA and assumed hydrogen recovery of 9% and PSA capex of 10% of the reformer cost. Argon is not expected to be present for hydrogen produced by an SMR and so no point is included for purifying Ar to 300 ppm for an SMR.**

Argon is only expected to be present if an autothermal reformer is used to produce hydrogen, due to the difficulty in separating argon from oxygen in air. The level of argon used in this report is based upon a single value used by Besancon et. al. in their model [45]. It may also be possible that the level of argon could be more cheaply reduced through adapting the air separation unit, rather than the PSA.

In the current model for argon removal with a PSA, Table 31 shows that there is also a significant amount of wasted hydrogen when the ISO/DIS 14687 [96] specification for Argon is met. As noted earlier, this would likely prompt a reformer redesign to reduce the hydrogen waste and reduce the costs of production.

The calculated additional costs for the removal of argon is therefore considered a very high upper bound on the costs of removing it and it will not be included in future graphs, in order to make trends in the data evident.

## 4.4.6 Methanation

### 4.4.6.1 Cost information

Methanation can be used to reduce the levels of carbon oxides to less than 50 ppm, by reacting them with the hydrogen product. Methanation is considered here as a potentially lower cost option than a PSA, for reducing carbon monoxide to a safe level. However, methanation cannot achieve a level of purity compatible with the ISO/DIS 14687 standard for vehicle PEMFC. The methanation reaction equations are shown below.

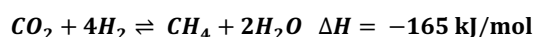
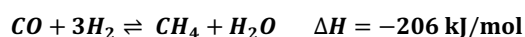

The methanation reaction uses hydrogen, and so the hydrogen output of the reformer is decreased. With 0.7 mol % CO<sub>2</sub> and 0.2 mol % CO present in the syngas after the WGS reaction, and both CO<sub>2</sub> and CO assumed to be reduced to 25 ppm respectively, the stoichiometry of Equation 1 and Equation 2 are used to calculate that 3.5 % of the hydrogen product is reacted. Methanation therefore has a significant impact on the LCOH.

It may be the case that the amount of CO removed could be reduced, with a reduced product loss and capital cost, by not pushing the methanation reaction towards completion. However, the detailed kinetic modelling of the methanation reaction is beyond the scope of this project, and methanation will therefore only be considered as a route to safe hydrogen with <50 ppm CO.

The impact of methanation on the LCOE is reduced compared to the impact on the LCOH. In the reaction, hydrogen is reacted to produce methane, which is also combustible and so releases energy when combusted in boilers and cookers. The methanation reaction is overall exothermic, so there is a slight reduction in the energy content of the product gas after the methanation reaction.

In the methanation reaction, carbon monoxide and carbon dioxide that would have otherwise been combusted and emitted at the point of use are reacted to form methane. This methane is then also combusted to produce carbon dioxide at the point of use. The methanation reaction is therefore assumed not to impact the carbon footprint of the process.

The amount of hydrogen product reacted, and hence the additional cost associated with methanation, will be dependent upon the levels of carbon monoxide and carbon dioxide present in the syngas. The sensitivity of cost of methanation to carbon dioxide levels in the ranges of values calculated in Table 42, of 0.35 mol% to 0.73 mol%, will be tested. Carbon monoxide levels at the lower end of the possible values after the water gas shift reaction, in the range of 0.1 – 1 mol % will also be examined.

Information provided by a stakeholder on the comparative capital costs of a reformer with a PSA and a reformer with a methanator is used to estimate the capital cost of a methanator to be 5-7.5% of the total capital cost of the reformer. As a central estimate we will use 6%.

In order to be compatible with transport through the gas network, hydrogen produced with a methanator requires a further step to remove water.

### 4.4.6.2 Water Removal

The upper limit on the amount of water that can be present is a water dew point limit of -10°C at 85 barg, which is roughly 30 ppm water (This is outlined in section 3.4 which covers sub task 1e).

In this analysis 30 ppm will hence be considered as the highest allowable level of water. Discussion with a stakeholder noted that water is usually removed from the syngas through standard condensation procedures when cooled to ambient temperatures. If cooled below this ambient temperature however, further water

would condense out of the syngas. Standard condensation procedures are therefore not compliant with the water dew point limit. Alternative methods must therefore be used to remove water if a PSA is not present.

Discussions with some stakeholders noted water removal to be through standard processes, and gave no further information, suggesting that cost associated would be insignificant. One suggested method was the use of an active filter for water removal. Another suggested method is using a desiccant drier, which is also used with electrolysis produced hydrogen. This costs ~5% of the electrolyser capital cost and uses 0-4% of the hydrogen product to regenerate the desiccant. In this study water removal costs will be tested for negligible costs of water removal, a central cost of water removal at 3% of the capex of the reformer and 2% product loss, and a high water removal cost of 5% of the capex of the reformer with a 4% product loss.

#### 4.4.6.3 Calculations

##### Impact: Hydrogen and Natural fired heater case

The methanation reaction causes a slight reduction in the energy content of the gas produced. If a natural gas fired heater is used, this impact, and the corresponding reduction in hydrogen in the product, is the only impact on the cost of hydrogen production.

In order to calculate the energy content of the new product gas, a syngas composition is assumed, and the stoichiometry of the reaction used to calculate the composition after methanation, assuming that carbon monoxide and carbon dioxide are both reduced to 25 ppm. The higher heating values of the combustible content ( $H_2$ ,  $CO$  and  $CH_4$ ) are then used to calculate the energy released in burning the product gas each for kWh of hydrogen combusted.

In the hydrogen fired heater case, the amount of energy that the fired heater requires is assumed to remain constant, and so a decrease in the energy content of product gas causes the fraction of the product gas combusted in the fired heater to increase.

Example flows of gases associated with methanation and water removal are shown in Figure 40 and Figure 41.

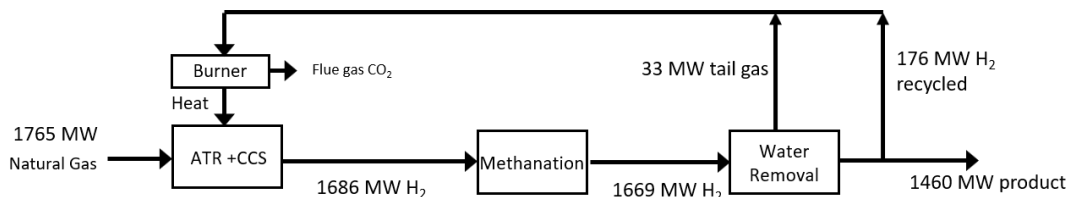

**Figure 40: Flows of gas demonstrating the impact of methanation and water removal on an ATR burning hydrogen**

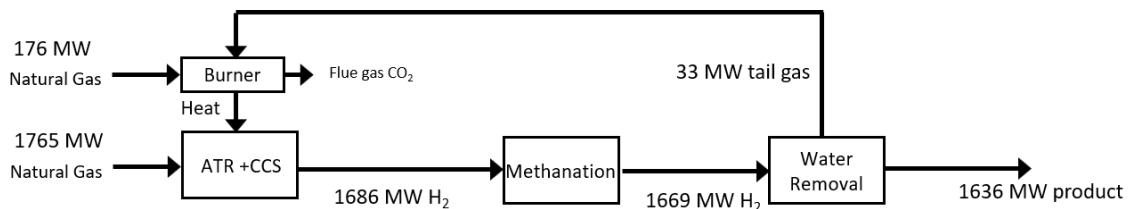

**Figure 41: Flows of gas demonstrating the impact of methanation and water removal on an ATR burning natural gas**

### Impact on LCOE and LCOH

The calculated costs associated with using methanation, assuming the central water removal costs referred to in Section 4.4.6.2 and that the methanation capital cost is 6% of the total reformer capital cost, are displayed in Table 33. This table also demonstrates that the impact of methanation is much larger on the LCOH than the LCOE. In later analysis this difference will be accounted for by adding the difference between the LCOH and LCOE as an additional cost for fuel cell users.

Reformer	ATR		SMR
Fired heater Fuel	H <sub>2</sub>	CH <sub>4</sub>	CH <sub>4</sub>
LCOE with methanation (p/kWh)	4.32	4.16	4.44
LCOH with methanation (p/kWh H <sub>2</sub> HHV)	4.48	4.32	4.61
LCOE no purification (p/kWh)	4.18	4.02	4.26
LCOH no purification (p/kWh H <sub>2</sub> HHV)	4.23	4.06	4.31

**Table 33: LCOE and LCOH comparison with and without methanation**

### Sensitivities

Table 34 displays the sensitivity of the calculated LCOE to the assumed capex of the methanator and Table 35 the sensitivity to the assumed water removal costs. The emboldened values are those assumed as the central scenario. Table 36 then displays the sensitivity to the assumed syngas.

Reformer:	ATR		SMR
Fired heater fuel	H <sub>2</sub>	CH <sub>4</sub>	CH <sub>4</sub>
Methanation Capex (% of total reformer)	LCOE (p/kWh)		
5 %	4.30	4.15	4.43
<b>6 %</b>	<b>4.31</b>	<b>4.16</b>	<b>4.44</b>
7.5 %	4.33	4.18	4.46

**Table 34: Cost of methanation: Sensitivity to assumed methanation capex**



Reformer	ATR		SMR
Fired heater fuel	H <sub>2</sub>	CH <sub>4</sub>	CH <sub>4</sub>
Water removal costs	LCOE (p/kWh)		
5 % capex and 4 % product loss	4.33	4.21	4.51
3% capex and 2 % product loss	<b>4.31</b>	<b>4.16</b>	<b>4.44</b>
Negligible costs	4.29	4.11	4.37

**Table 35: Cost of methanation: Sensitivity to assumed water removal costs**

Reformer		ATR		SMR
Fired heater fuel		H <sub>2</sub>	CH <sub>4</sub>	CH <sub>4</sub>
Assumed syngas	Hydrogen loss	LCOE (p/kWh)		
CO 0.1 mol % CO <sub>2</sub> 0.7 mol%	3.3%	4.31	4.16	4.45
CO 1 mol % CO <sub>2</sub> 0.7 mol%	6.1%	4.32	4.16	4.45
CO 0.2 mol % CO <sub>2</sub> 0.35 mol%	2.0%	4.30	4.15	4.43
CO 0.2 mol % CO <sub>2</sub> 0.73 mol%	3.6%	4.32	4.16	4.45

**Table 36: Cost of methanation: Sensitivity to assumed syngas**

Table 36 shows that the impact of varying the assumed syngas on the LCOE is smaller than the other sensitivities tested, despite the wide variation in hydrogen loss. The hydrogen lost reacts to form methane, which still provides energy to the end user when combusted, and so a large range in hydrogen losses translates to a much smaller impact on the LCOE. The impact on the LCOH however, would be much larger.

Figure 42 compares the impacts of the assumed water removal costs and methanation capital costs on the LCOE calculated when methanation is used as a purification step for each type of reformer investigated. For all the reformers considered, the impact of water removal costs is higher. The range of values given by varying the water removal costs within their plausible range will therefore be selected as the range of values associated with methanation in further analysis.

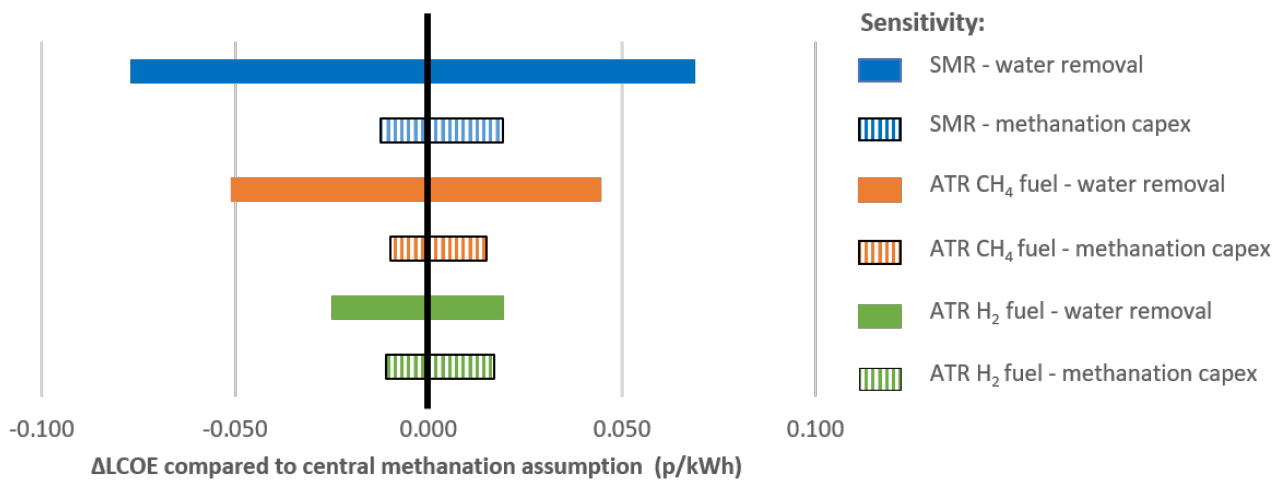
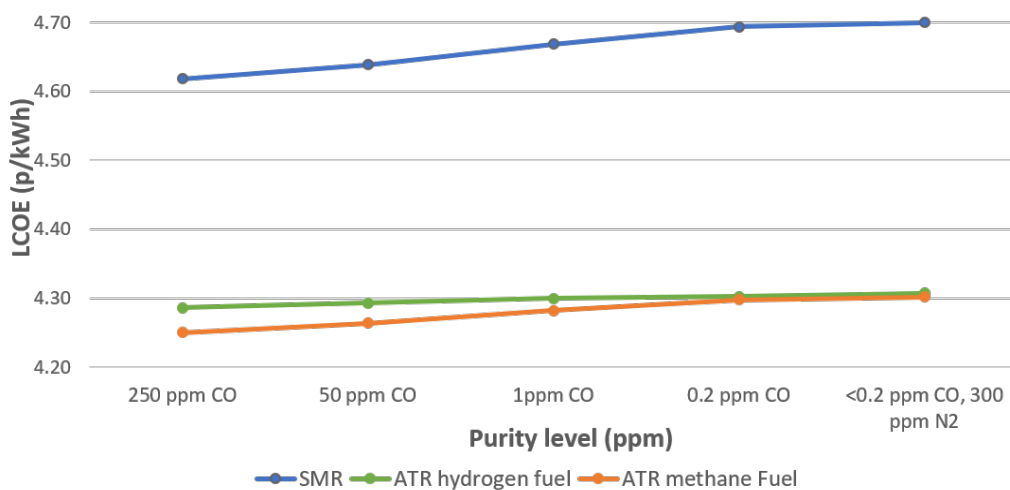

**Figure 42: Comparison of the impacts of the range of assumed methanation capital costs, outlined in Table 34, and water removal costs, outlined in Table 36 on the LCOE with methanation.**

#### 4.4.7 Production cost trade-off with purity

The calculated levelised costs of energy are summarised in Table 37 and Figure 43. There are different costs associated each of the reformers examined in this model. These costs should not however be used to select a choice of reformer, they are instead used to look at the potential range of additional costs associated with different purity levels.

Each of the reformers routes is associated with different CO<sub>2</sub> emissions, and so varying carbon emissions restrictions will give different ranges of additional costs associated with increasing purity. These ranges of additional costs will be presented in the following sections, Table 37 outlines the carbon dioxide emitted due to each production process and the point at which carbon is captured. This data is taken from the H21 report.



**Figure 43: LCOE calculated for different production routes and purity levels using a PSA for purification.**

Reformer		ATR	ATR	SMR
Fired heater fuel		H <sub>2</sub>	CH <sub>4</sub>	CH <sub>4</sub>
CO <sub>2</sub> Emissions (g/kWh)		8	30	20
CO <sub>2</sub> capture		HP CC from syngas only	HP CC from syngas only	HP CC from syngas and LP CC from fired heater flue gas
Purity level	Purification	LCOE (p/kWh)		
No purification	None	4.18	4.02	4.26
CO <50 ppm	Methanation	4.31	4.16	4.44
CO < 250 ppm	PSA	4.29	4.25	4.62
CO < 50 ppm	PSA	4.29	4.26	4.64
CO < 1 ppm	PSA	4.30	4.28	4.67
CO <0.2 ppm	PSA	4.30	4.30	4.69
CO <0.2 ppm, N <sub>2</sub> <300 ppm	PSA	4.31	4.30	4.70
CO <0.2 ppm, Ar <300 ppm	PSA	4.82	4.82	5.10

**Table 37: Calculated LCOE associated with varying levels of purity.**

#### 4.4.7.1 Most stringent CO<sub>2</sub> emissions intensity (< 9 g/kWh)

If scope 1 carbon dioxide emissions of less than 9 g/kWh are required (a 95% saving compared to natural gas), then only an ATR with HP CC from the syngas and hydrogen as a fuel for the fired heater meets this requirement. Figure 56 displays the annual costs, to an illustrative typical household, associated with using a PSA to purify to increasing levels of purity for this reformer. A typical household here is assumed to use 12,600 kWh of hydrogen a year for heating and cooking, matching Table 3.03 in the BEIS EC UK data in [97].

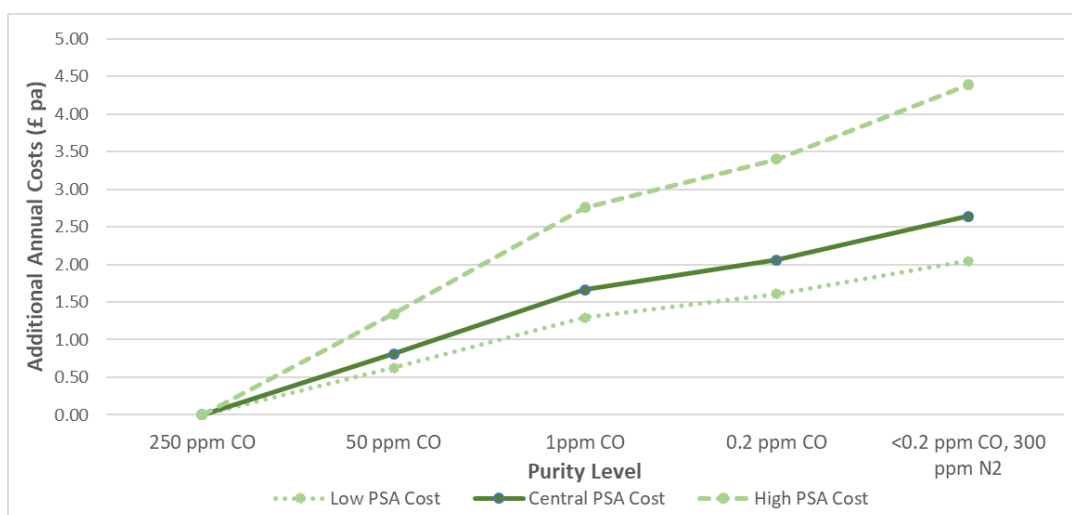

**Figure 44: Calculated annual additional costs, compared to reducing CO to 250ppm, for a typical household when a PSA is used to increase purity levels for an ATR using hydrogen as a fuel for the fired heater.**

The additional costs associated with purifying to 1 ppm of carbon monoxide, compared to 250 ppm, are between an additional £1.30 and £2.80 to the typical household. For an ATR using hydrogen as the fuel for a fired heater, methanation does not offer a significantly cheaper option to reach CO levels of less than 50 ppm compared to a PSA used to purify to 250 ppm CO or 50 ppm CO. Figure 57 shows this comparison.

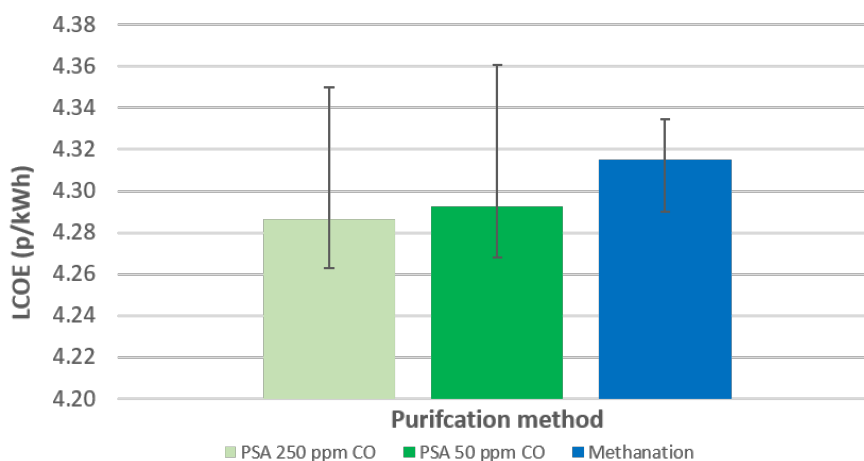

**Figure 45: Comparison of costs associated with using a PSA and methanation for purification with an ATR using hydrogen as a fired heater fuel. Error bars display the range of LCOEs associated with the range of plausible PSA capital costs and water removal costs for methanation.**

#### 4.4.7.2 Less stringent CO<sub>2</sub> emissions intensity (<20 g/kWh)

If scope 1 carbon dioxide emissions of less than 20 g/kWh are required (~90% emission saving compared to natural gas), then an SMR, with both HP CC from the syngas and LP CC from the fired heater flue gas, can be used to produce hydrogen as well as the ATR using hydrogen as a fuel for the fired heater. The additional cost to a typical household associated with increasing purity using a PSA, for each of these reformers, is displayed in Figure 46.

The impact that a PSA has on the costs of purifying hydrogen produced by an SMR are higher than for an ATR burning hydrogen. For carbon dioxide emissions of less than 20 g/kWh, using a PSA to purify hydrogen to 1 ppm CO instead of 250 ppm could give an additional cost of between £1.30 and £7.90 annually to a typical household. While purifying to the ISO/DIS 14687 vehicle PEMFC standard for carbon monoxide could give an additional cost of between £1.60 to £12.70 annually.

When an SMR is used to produce hydrogen, methanation offers a saving of between 0.08 and 0.33 p/kWh compared to using a PSA to purify to 250 ppm CO. This is equivalent to savings of between £10 and £42 annually for typical household. This range is calculated by calculating the highest and lowest plausible LCOEs using methanation and a PSA, and then calculating the highest and lowest possible differences between these. If the central assumptions of this report are used for both the PSA and Methanation, this saving is £22 annually.

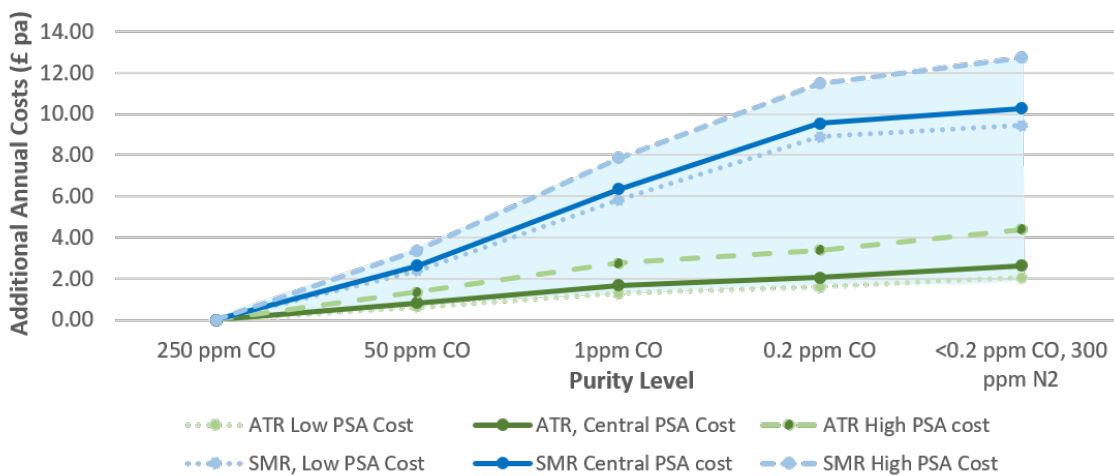

**Figure 46: Range of potential annual additional costs to a typical household, associated with using a PSA to increase the purity beyond 250 ppm CO, with carbon dioxide emissions of less than 20 g/kWh**

The inclusion of methanation as a cheaper option means that for an SMR, purifying to 50 ppm carbon monoxide has no additional costs compared to 250 ppm. However, the additional cost of increasing the purity beyond 50 ppm CO is significantly increased, as a PSA needs to be added. For example, increasing the purity requirement from 50 ppm CO to 1 ppm could now add between 60p and £50 to the typical household. The additional cost is dependent upon the reformer used. The lower value, 60p corresponds to lowest plausible additional cost in using a PSA to purify to 1ppm instead of 50 ppm for production by an ATR with hydrogen fired heater fuel. The higher value, £50 is the highest potential additional cost<sup>1</sup> associated with using methanation to reach <50ppm CO and a PSA to reach 1 ppm CO for the SMR. Figure 48 demonstrates the impact of including methanation in the cost considerations.

<sup>1</sup> The difference between the lowest methanation LCOE and highest plausible PSA LCOE at 1ppm.

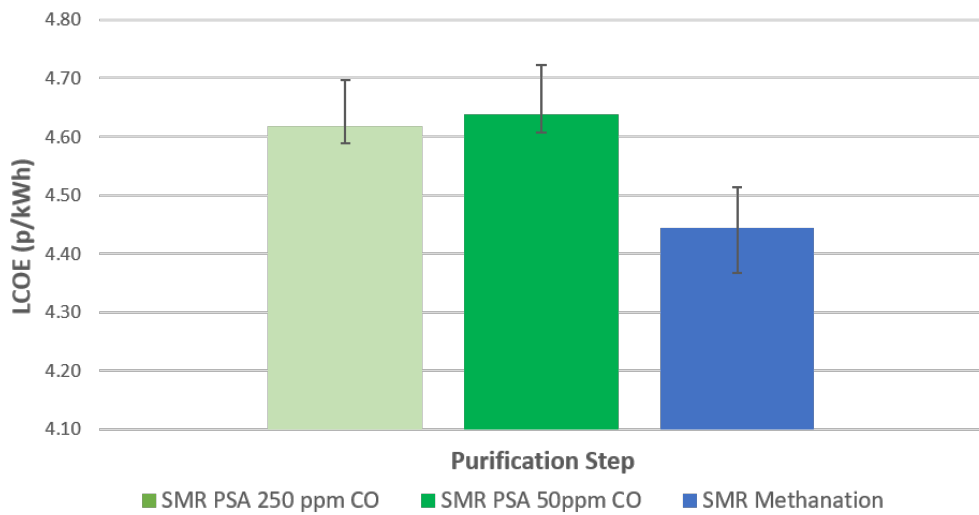

**Figure 47: Comparison of the costs of using methanation to reach less than 50 ppm CO and a PSA to reach 250 ppm and 50 ppm CO for an SMR.**

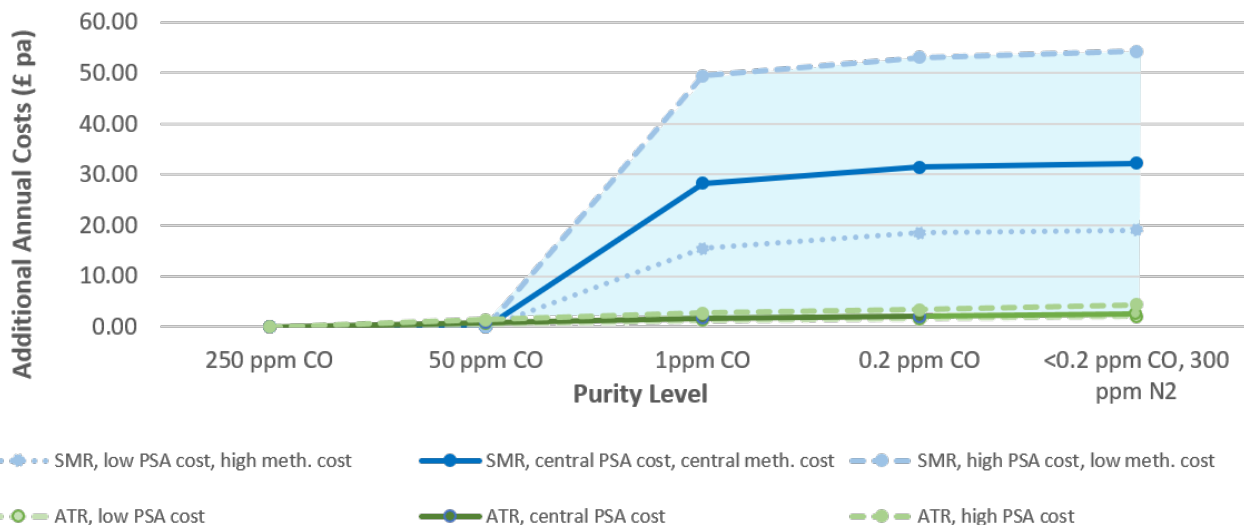

**Figure 48: Additional costs to a typical household associated with increasing levels of hydrogen purity, when methanation is included as a viable option for purifying hydrogen.**

Further relaxation of the carbon dioxide emissions required, will also allow production with an ATR using methane as the fired heater fuel and carbon capture at high pressure from the syngas but no carbon capture from fired heater flue gas. Figure 33 shows that the additional cost of increasing purity with a PSA on the ATR using methane as a fired heater fuel lies between the additional costs to the SMR and ATR using hydrogen as a fired heater fuel. Therefore, this option does not give any further increase in the range of additional costs associated with increasing purities.

#### 4.4.7.3 A note on the removal of inert gases

For all of the production routes considered, additional costs to remove argon to the level specified by the ISO/DIS 14687 standard for vehicle PEMFC [8] were found to be greater than £50 annually to a typical household. This cost however, is based upon a single data point used in the study by Besancon et.al [45], with 0.7 mol% argon present in the syngas produced by an ATR. In this range the model calculations

overestimate the costs associated with hydrogen production to this level of purity, as significant amounts of hydrogen are assumed to waste in the PSA tail gas. This argon level may also be reduced for a lower additional cost through changing the design of the air separation unit used to produce the oxygen feed for the ATR.

For hydrogen produced by an SMR, argon is not anticipated to be present, and the costs of removing nitrogen to the level specified by the ISO/DIS 14687 standard for vehicle PEMFC [96] are not significantly higher than those to reduce carbon monoxide to levels that meet this standard.

#### 4.4.7.4 Conclusions

If the carbon emission intensity of hydrogen is limited to less than 9 g/kWh (HHV), then decreasing levels of carbon monoxide below 250 ppm are shown in Figure 50. Additional costs of purifying to the ISO/DIS 14687 standard for vehicle PEMFC [8], for all impurities except for argon, were found to be between 0.016 and 0.03 p/kWh. This correspond to an additional cost of between £2.10 and £4.40 to the typical household.

Where a higher carbon emission intensity of 20 g/kWh (HHV) is permitted, then an SMR is also a feasible option for producing hydrogen. In this case, methanation offers a lower cost route to reaching 50 ppm carbon monoxide than a PSA.

This means that, for a carbon emission intensity limit of 20 g/kWh, the additional cost of increasing the CO purity level to reach 50 ppm compared to 250 ppm ranges from zero to £1.30 annually, for a typical household. This consideration of methanation is taken from the perspective of hydrogen being combusted, where the energy released in burning the methane introduced to the hydrogen by methanation is valuable to the end user. For fuel cell applications, the costs associated with methanation are significantly higher as the methane introduced to the product is not usable and has to be separated from the gas.

The costs associated with decreasing the carbon monoxide level below 50 ppm then vary widely, due to the different costs associated with purification steps for the ATR using H<sub>2</sub> to provide heat and for the SMR. Additional annual costs of between 0.005 p/kWh and 0.39 p/kWh, £0.60 and £52 for the typical household, are found for increasing the carbon monoxide purity from 50 ppm to 1 ppm.

### 4.5 Costs downstream of production

The costs downstream of production, associated with varying levels of hydrogen purity, are outlined in Figure 49. This section will first look at the impact of varying levels of purity on potential end users of hydrogen in the gas grid, followed by the costs of purifying hydrogen for these applications at the point of use. Indicative values for the additional costs associated with transporting inert gases in the pipes and sampling and verifying differing level of purity at different points are then estimated in Section 4.5.3.

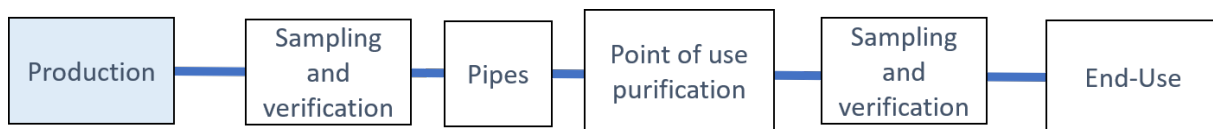

**Figure 49: An outline of the costs associated with varying levels of purity of hydrogen downstream of production**

Content or characteristic	Value	Rationale
Hydrogen fuel index (minimum mole fraction)	98 % (cmol mol <sup>-1</sup> )	This value is a good compromise between hydrogen cost and effects on boiler.
Carbon monoxide	20 ppm (μmol mol <sup>-1</sup> )	A practical engineering limit based on achievable production limits and to meet long term exposure limits HSE EH/40)
Hydrogen sulphide content	≤ 5 mg m <sup>-3</sup> 3.5 ppm (μmol mol <sup>-1</sup> )	These values are taken from GSMR:1996 as any detrimental effects would be similar for hydrogen and natural gas, in a repurposed pipeline network.
Total sulphur content (including H <sub>2</sub> S)	≤ 50 mg m <sup>-3</sup> 35 ppm (μmol mol <sup>-1</sup> )	
Oxygen content	≤ 0.2 % (cmol mol <sup>-1</sup> )	
Hydrocarbon dewpoint	-2 °C	Complies with GSMR:1996 and EASEE-gas, and avoids liquid drop-out
Water dewpoint	-10 °C	
Sum of methane, carbon dioxide and total hydrocarbons	≤ 1 % (cmol mol <sup>-1</sup> )	No detrimental effects to boiler, this limit is to reduce carbon content of the exhaust
Sum of argon, nitrogen and helium	≤ 2 % (cmol mol <sup>-1</sup> )	To avoid transporting inert gases with no calorific value in the hydrogen gas (in agreement with ISO/FDIS 14687) and to limit the impact on Wobbe Number (see below)
Wobbe Number range	42 – 46 MJ m <sup>-3</sup>	Range and percentage variation based on natural gas range in GSMR1996  Wobbe Number is calculated at UK metric standard conditions of 15 °C and 101.325 kPa
Other impurities	The gas shall not contain solid, liquid or gaseous material that might interfere with the integrity or operation of pipes or any gas appliance, within the meaning of regulation 2(1) of the Gas Safety (Installation and Use) Regulations 1998, that a consumer could reasonably be expected to operate	

**Table 1: Draft recommendation for a UK hydrogen quality standard for heat applications based on existing standards and documents**



## 4.5.1 Impact on end-user

This section summarises the impact that the impurities found in hydrogen production will have for prospective end-users of hydrogen transported using the gas grid. In some cases, it has not been possible to derive a cost associated with the impact of the impurities, and we highlight where further work would be required to achieve this.

### 4.5.1.1 Boilers and cookers

Hydrogen boilers and cookers will combust hydrogen and so are tolerant to the impurities found in reformer produced hydrogen. A stakeholder engagement exercise conducted by NPL found that a draft standard, displayed in Table 1, would not have any significant impact on the cost of using hydrogen in boilers and cookers. We therefore assume that there is no additional cost for boilers and cookers associated with the different hydrogen purities considered here. Potential safety concerns were raised regarding the level of carbon monoxide, and so this study will look at the additional costs associated with reducing the carbon monoxide level further.

Element Energy and Jacobs have investigated the impact of converting industrial appliances to hydrogen as part of WP6 of the Hy4Heat programme. It was noted in this work that CO, CH<sub>4</sub>, inert gases and H<sub>2</sub>O would have minimal impact on applications in industry that would have otherwise burnt natural gas. We therefore assume no additional costs associated with the levels of purity at point of production for this study.

### 4.5.1.2 Solid oxide fuel cell

One stakeholder noted that the performance of a high temperature solid oxide fuel cells (SOFC) is impacted by the presence of sulphur, phosphorous, silicon or halides. A sulphur level of < 1 ppm was considered acceptable and it was noted that clean-up would be required if higher levels of sulphur were present. It was also highlighted that hydrocarbons may be an issue due to the deposition of carbon, but testing has not been carried out to determine a threshold for this.

There would therefore likely be a cost of clean-up associated with removing sulphur if levels of greater than 1 ppm are found in the hydrogen produced. In hydrogen produced by a reformer, sulphur was found by the EMPIR hydrogen study [1] to be reduced less than 50 ppb, and so sulphur levels present in this study are not an issue for SOFC, unless sulphur compounds are used in an odorant.

Methane present in the hydrogen product may cause an issue, due to the deposition of carbon, but we do not have data available to verify the magnitude of this impact. For PSA purified hydrogen, where methane levels are low, it is assumed here that this is not an issue. For hydrogen purified by methanation, this may however cause an issue.

### 4.5.1.3 Proton exchange membrane fuel cells

Proton exchange membrane fuel cells (PEMFCs), also known as polymer electrolyte membrane fuel cells, are significantly less tolerant of impurities than the other end-uses.

Specifications given for vehicle and stationary applications of these fuel cell can be found in the ISO/DIS 14687 standard [96]. Three categories can be found for the stationary fuel cells, Category 3 will be used for this report, as categories 1 and 2 were noted by a stakeholder to be applicable to niche uses by a stakeholder.

The specifications for stationary fuel cells and fuel cell vehicle are the same for all of the impurities considered in this report, except for the total acceptable level of non-hydrogen components. For stationary fuel cell applications this is 0.1 % and for vehicle applications is 0.03 %. The impact that each of these impurities has on fuel cell is outlined. Calculations of costs associated with these values requires further review of the mitigation methods used and the costs associated with these.

The detailed investigation and modelling of the impact of impurities on PEMFC's and the mitigation of these impacts, which would be required to obtain an accurate cost associated with each level of purity, is not included in this study. Instead we point towards some data that outlines the impact of these impurities and methods for mitigation, which could form the basis of further work.

The key impurities to consider in PEMFC are carbon monoxide and sulphur, which have significant impact on the fuel cell catalyst, and the impact of inert gases, as these were shown in section 4.4.7 to be potentially costly to reduce to the levels specified by the ISO/DIS 14687 PEMFC standard.

### **Carbon monoxide**

Carbon monoxide blocks sites on the catalyst and hence reduces the output voltage of the cell. Besancon et. al. [45] and the US Department of Energy [99] have studied the impact of impurities on fuel cells.

Besancon et. al. [45] found that with the presence of 9 ppm CO in the hydrogen feed to a PEMFC, the cell voltage steadily decreased to be below a usable value (<50% of the target voltage) after 3.4 hours. We will therefore assume that greater than 9 ppm CO is unusable for a PEMFC and clean-up is required. For levels of 4.5 ppm and lower, a reduced steady state voltage was found to be reached. A reduction of 42% compared to cell voltage using pure hydrogen was found at 4.5 ppm CO, and a 20% reduction at 1 ppm CO. For 0.52 ppm a much smaller voltage drop, of 4.3% was observed after 76 hours.

Besancon et. al. also note that carbon monoxide poisoning is reversible. It was observed that by running the fuel cell with pure hydrogen the cell voltage loss caused by CO could be reversed.

Methods to reduce the impact that carbon monoxide has on fuel cells, are available. For example SINTEF [24] have looked at using an air-bleed to encourage the oxidation of carbon monoxide. These methods may however have an impact on the lifetime and efficiency of the fuel cell.

The costs associated with the reduction in the fuel voltage, and a comparison with the potential costs of a carbon monoxide poisoning mitigation strategy need to be examined in more detail in order to estimate the costs associated with carbon monoxide poisoning.

### **Sulphur**

Sulphur binds to the platinum catalyst in a PEMFC, in a similar way to carbon monoxide. However, its impact is very difficult to reverse [4]. Its impact therefore accumulates and steadily increases over the lifetime of the FC catalyst. This study therefore assumes that sulphur must be reduced to the levels specified in the fuel cell standards, in order to be used in a PEMFC.

### **Inert Gases**

No discernible dilution impact on fuel cell performance is anticipated by Besancon et. al. [45] for inert concentrations of less than 1%. For larger impacts the cell voltage reduction can be calculated using the reduced partial pressure of hydrogen and the Nernst equation, Equation 1.

$$\Delta V = \frac{RT}{2F} \ln \left( \frac{P_2}{P_1} \right)$$

**Equation 1: Nernst Equation  $\Delta V$  is the voltage change, R is the gas constant, F is Faradays constant, T is temperature and P the partial pressure of hydrogen.**

Unreacted hydrogen is often recycled back to the fuel cell, which means that if inert gases are present, they will accumulate [99], [45] and so their impact on fuel cell voltage will increase with time. This can be fixed



by venting the fuel cell periodically, the impact that this venting will have on the costs associated with using hydrogen with high levels of inert gases requires further investigation to be quantified.

#### **4.5.1.4 End-use impact Summary**

Table 38 summarises the impact that the purity levels examined in this report would have on the end users considered. Due to this study focussing on the impact for heating end-uses rather than PEMFC, a detailed investigation of the costs associated with these impacts has not been carried out. Instead it will be assumed that downstream clean-up is required where a given production purity has an impact for an end-user.

**Table 38: Green denotes no impact of that impurity level on the fuel cell, yellow denotes some impact on performance, and red denotes an impact that is likely to be unacceptable, meaning that clean-up would be required.**

Purification Step	Purity Level	Impact on end-user			
		Boilers and Cookers	Industrial User	SOFC	PEMFC
Methanation	CO <50 ppm			Potential hydrocarbon deposition issue	Sulphur poisoning
PSA	CO < 250 ppm and other impurities reduced				CO poisoning, requiring frequent catalyst replacement
PSA	CO < 50 ppm				CO poisoning, requiring frequent catalyst replacement
PSA	CO < 1 ppm				CO poisoning + Inert gases dilution and accumulation
PSA	CO <0.2 ppm				Inert gases dilution and accumulation
PSA	CO <0.2 ppm, N <sub>2</sub> <300 ppm				
PSA	CO <0.2 ppm, Ar <300 ppm				

## 4.5.2 Point of use purification

### 4.5.2.1 Purification technologies available

A study of clean up technologies available, undertaken by DNV-GL in Task 2c of this project, has not yet been published. However, we understand from discussions with DNV-GL that there are few technologies currently available for the clean-up of impurities such as carbon monoxide and inert gases at the point of use for individual households. The technologies available for this use are simple scrubbers and de-sulphurisers. The cost of a de-sulphuriser is outlined in the next section.

For the use of hydrogen in PEMFC transport applications, purification could also be applied on the forecourt of hydrogen refuelling stations (HRS). Technologies that could be used to purify hydrogen for individual households and on the forecourt of hydrogen refuelling stations (HRS) are polymer membranes, Pd-based membranes and electrochemical purification. The latter two of these technologies are noted in stakeholder discussions, to be at TRL 5-6, and so their use is dependent upon further development.

For hydrogen purification on the forecourt of a HRS, temperature and pressure swing adsorbers (TSAs and PSAs) may also be available for purification. The costs associated with Pd-based membranes, PSAs and TSAs for use at point of production were outlined in the report on production and purification technologies available in Tasks 1c/1d. These costs however are not applicable to clean-up on the refuelling station forecourt, due to the difference in scale and the difference in pressures and temperatures of the hydrogen gas at the forecourt compared to in a reformer. Further study of the costs and applicability of these technologies to purifying hydrogen from a gas grid on the forecourt of a HRS is required.

To provide a handle on the potential costs associated with clean-up technologies, either at the point of use or on a refuelling station forecourt, the targets associated with two EU projects demonstrating prototype systems for the separation of hydrogen from gas mixtures will be used. These two projects are the Hygrid project [76] and MEMPHYS project [75].

Hygrid is a three year project that started in May 2016 and targets the separation of hydrogen from a hydrogen-natural gas mixture in the gas network. The MEMPHYS project is a three year project started in January 2017 which designs a hydrogen purification system to allow the re-use of hydrogen from various industrial sources. The cost savings associated with using these technologies with reduced input impurity levels have not been found during this study and so these costs are treated as fixed, independent of the input purity.

#### **Removing impurities introduced by the pipes**

The study of the impurities introduced to hydrogen during transport in the gas grid is being carried out for the Cadent HG2V project and will feed into this report through Task 1g of this work package. These results are yet to be published. Discussions held at a workshop led by the HG2V project highlighted the potential presence of black dust, sulphur and other particulates.

The technologies available to remove these impurities, based on discussions with DNV-GL, will be simple scrubbers and de-sulphurisers, which will not have the capacity to remove impurities such as carbon monoxide and inert gases that remain after production by reformers. Removing the impurities introduced by the pipes therefore do not affect the choice of production purity, instead they add a fixed cost for fuel cell applications that use hydrogen transported through the grid.

The technologies proposed by the MEMPHYS and Hygrid project should also remove the impurities studied in the grid: The HyGrid purifier targets hydrogen separation from a natural gas and the MEMPHYS purifier targets the recovery of hydrogen from a variety of industrial sources and includes an anti-poisoning strategy [75].

## 4.5.2.2 Costs

### De-sulphurisation

De-sulphurisation units are currently used in  $\mu$ -CHP applications to remove the sulphur used as an odorant in natural gas. Discussion with a stakeholder suggested the costs of a de-sulphuriser are currently in the region of €80-90 per year, reducing to €40-45, £34-£39<sup>1</sup> in two to three years' time if demand increases. The key component of this cost is the replacement of the catalyst, which needs to be replaced on average every two years when purifying from an initial sulphur level of ~20 ppm down to <1 ppm.

This type of desulphurisation technology would only be required if a sulphur containing odorant were used in hydrogen, or if hydrogen were to pick up sulphur compounds remaining in the gas grid itself. If required, it adds a fixed cost to the use of all fuel cells which is independent of the purity chosen during hydrogen production.

The costs of reducing sulphur levels from the < 50 ppb found in reformer produced hydrogen without a PSA, to the 4 ppb specified by the ISO/DIS 14687 standard, will differ from the costs noted above.

### MEMPHYS

The MEMPHYS project uses a membrane and an electrochemical cell to purify hydrogen. The targeted parameters of the MEMPHYS project are displayed in Table 39.

Parameter	Value	Unit
H <sub>2</sub> production rate (kg/day)	5	Kg/day
Energy consumption	< 5	kWh/kg H <sub>2</sub>
Capex	< 1,500	€/(kg H <sub>2</sub> /day)
Output pressure	200	bar
Feed gas temperature	20-80	°C
Feed gas pressure	1.05-100	bar

**Table 39: Targeted parameters for the MEMPHYS project [75]**

An estimate of the costs associated with using this technology for the purification hydrogen used in a PEMFC a  $\mu$ -CHP system for a typical household can be estimated using the BEIS ECUK data [97]. It is assumed that the  $\mu$ -CHP system does not provide energy for use in cooking. The typical use of gas for space and water heating, not including cooking, per household is 12 300 kWh per year, 33.7 kWh per day. This requires 0.9 kg of hydrogen per day, equating to a capex of €1,500 or £1290<sup>2</sup>. A targeted lifetime of the device is not quoted. In order to calculate an annual additional cost to the end user, an estimated lifetime for the technology of 7 years is assumed, using the 60,000 hour 2020 target for stationary fuel cells given by the US department for Energy [114]. Using the electricity price assumed in Table 26 of £46/MWh, this gives an additional cost to the average gas user of £255 per year or 2.1 p/kWhH<sub>2</sub>. The same additional cost, in p/kWh, is also calculated for purification on the forecourt of a HRS.

### HyGrid

The HyGrid project [76] considers the use of a membrane, electrochemical compressor and TSA to recover hydrogen from a natural gas grid. In a preliminary project design, a system targeting 50 kg/day of hydrogen

<sup>1</sup> Using exchange rate on 4.3.19: € 1 = £ 0.86

<sup>2</sup> Using exchange rate on 4.3.19: € 1 = £ 0.86

is modelled to have a heat consumption of 6.21 kWh/kgH<sub>2</sub> and electric consumption of 2.18 kWh/kgH<sub>2</sub>. [115] The cost target of the project is <1.5 €/kgH<sub>2</sub> or <1.29 £/kgH<sub>2</sub>.

If the heat is assumed to be provided by burning hydrogen, at the cost modelled by the H21 report of 5 p/kWh, and an electricity cost of £46/MWh is assumed, then the cost of hydrogen purification is calculated to be 4 p/kWhH<sub>2</sub>. Note that this project has not yet completed a detailed cost and energy analysis.

#### **4.5.2.3 Summary**

The costs of removing sulphur from hydrogen with a sulphur based odorant, for use in a SOFC, is anticipated to be £34-£39 per year.

The costs of removing all impurities found in hydrogen, in order to meet the ISO/DIS 14687 standard for vehicle PEMFC [8] is calculated to be between 2.1 – 4 p/kWh, using targeted values of the MEMPHYS and HyGrid European projects. These numbers are preliminary estimates, based upon the target costs of demonstration projects for pre-commercial technologies, and should be considered highly uncertain. Nonetheless, they indicate the potential order of magnitude of the costs associated with clean-up.

No data is available on the potential cost reductions for these technologies if the purity of the hydrogen in the grid were increased.

### **4.5.3 Additional downstream costs considered**

#### **4.5.3.1 Pipe transport costs**

There is a cost associated with transporting high levels of inert gases to the end user, due to the carrying capacity of the grid being 'wasted' where it is not being used to transport useful gas. This cost is examined to see if has a noticeable impact at the level of inert gases that may be found in the reformer product of up to 2%.

Transmission charges for a gas consumer, using 12,500 kWh per year, are given in 2016 study of regional difference in network charges by Ofgem [95]. The sum of the transmission and distribution charges range between £131 and £166 per year, dependent upon the customers location, amounting to between 1.05 p/kWh and 1.33 p/kWh of gas transported.

To estimate the additional costs associated with transporting inert gases we assume that the transmission and distribution charges are associated with the volume of gas transported. If the gas is 98 mol% hydrogen and 2 mol% inert, we assume that 2% of the volume transport is wasted and calculate the new charge by dividing the transmission and distribution charges by 0.98. This gives additional charges of 0.02 – 0.03 p/kWh, if 2 mol% of inert gases are transported. The costs associated with transporting the additional inert gases potentially present at each purity level are shown in Table 40.

Note the costs assigned here are calculated using the anticipated levels of argon present if an ATR is used, if an SMR is used, the nitrogen levels will be lower and hence the cost reduced even further.

---

<sup>1</sup> This quoted cost, given a lack of clarity in the project information, is assumed to be the targeted capital cost.

Purity Level Production Route		Inert transport additional costs (p/kWh)	
		Min	Max
No purification	None	0.024	0.03
CO <50 ppm	Methanation	0.014	0.017
CO < 200 ppm and other impurities removed	PSA	0.004	0.005
CO < 50 ppm	PSA	<0.004	<0.004
CO < 1 ppm	PSA	<0.004	<0.004
CO <0.2 ppm	PSA	<0.004	<0.004
CO <0.2 ppm, N <sub>2</sub> <300 ppm	PSA	Negligible	Negligible
CO <0.2 ppm, Ar <300 ppm (ATR)	PSA	Negligible	Negligible

**Table 40: Cost associated with transporting additional inert gases in the gas network**

#### 4.5.3.2 Sampling and verification costs

Sampling and verification of hydrogen is required to ensure that the hydrogen present in the grid meets whatever standard is set. This will have an associated cost.

A thorough study of sampling options and the costs associated is not within the scope of this study. Instead indicative costs will be used to determine whether this cost could have a significant impact in a decision on the appropriate purity.

A discussion with a colleague at NPL, with expertise in standards and sampling, noted that there are two options for online analysis of hydrogen. One option is a sensor, to alert when an impurity is over a certain level, and the other is an online analyser which monitors the levels of selected impurities in real time. A sensor was anticipated to have a capital cost of roughly £5k and an online analyser £20-40k. The potential variation in costs with the targeted levels of purity were not available; a more in-depth consultation with an OEM would be required to do this. However, it was noted that there would likely be little difference in the costs of verifying 200 ppm CO compared to 20 ppm.

The maintenance and calibration costs are estimated using the current costs of calibrating the gas chromatography units that verify the natural gas currently in the grid. These costs were determined by a stakeholder engagement exercise by DNV GL. The calibration gases cost around £1200-1500 per site per annum, for an automated calibration process, and the annual maintenance costs are assumed to be around £1000 per site per annum.

Given that we do not have data specific to the sampling costs associated with each level of purity, some specific cases that present the likely largest range of differences in sampling costs will be examined.

Case (a) will consider that hydrogen is produced to a safe standard at the point of production (POP), and only a sensor is required to verify this standard. Each hydrogen refuelling station will then have an online analyser to verify the PEMFC standard.



In the alternative case (b), we will consider hydrogen produced centrally to the ISO/DIS 14687 PEMFC vehicle standard and verified by one online analyser per reformer, with no further verification required. Note that this is an unlikely case, as verification may be required at the HRS to ensure that no further impurities have been introduced by the grid, but it is used as the cheapest case for reference. The costs associated with these cases are outlined in Table 41.

In calculating the values in Table 41, lifetimes of 10 years have been assumed for both equipment types. It has also been assumed that a sensor does not require calibration gases, and so just has annual maintenance costs of £1000 per year. A refuelling station size of 200 kg/day has been assumed.

Sampling case	Sampling at point of production	Costs at POP (£ thousand per site per year)	Additional Production Cost (p/kWh)	Sampling at HRS	HRS Costs (£thousand per HRS per year)	Additional cost at HRS (p/kWh)
(a)	Sensor	1.5	$2 \times 10^{-5}$	Online analyser	4.2-6.5	0.15-0.23
(b)	Online analyser	4.2-6.5	$5-7 \times 10^{-5}$	None	0	0

**Table 41: Costs associated with sampling and verification of hydrogen at the point of production (POP) and hydrogen refuelling station (HRS)**

#### 4.5.4 Summary

Table 42 summarises the additional costs, downstream of production, associated with the differing levels of purity considered. Costs associated with the transport of inert gases in the product, sampling and verifying the fuel standard of hydrogen at either the point of production (POP) or at a hydrogen refuelling station (HRS), the impact of impurities on end-uses and the cost associated with purifying at the point of use are summarised.

The difference between the LCOH and LCOE for each given purity is also included in Table 42. It assumed that users of hydrogen in fuel cells, only pay for the hydrogen through the levelized cost of hydrogen (LCOH), while combustion users make use of the combustible impurities and pay a levelized cost of energy. The LCOH is therefore higher than the LCOE. This difference is included in this analysis as an additional cost to the end user.

Table 42 shows that the highest costs downstream of production are the sampling costs at the HRS, the costs of clean-up for use in PEMFC and the additional difference between the LCOE and LCOH when methanation is used. Table 42 also highlights that the impact of impurities on costs to end users is only significant for a end-users with PEMFCs.

**Table 42: Summary of costs downstream of production associated with each level of purity considered. Emboldened costs are those noted to be the most significant costs.**

Purification	Purity Level	Transport Costs	Sampling Costs (POP)	Sampling Costs (HRS)	Combustion Uses	Additional SOFC costs	Additional PEMFC Costs		LCOH minus LCOE
		(p/kWh)	(p/kWh)	(p/kWh)		(p/kWh)	Lifetime / Efficiency	Clean-up (p/kWh)	(p/kWh)
<b>None</b>	<i>No purification</i>	<b>0.02-0.03</b>					<b>Unsafe</b>		
<b>Methanation</b>	CO <50 ppm	0.01-0.02	2 x 10 <sup>-5</sup>	<b>0.15-0.23</b>	0	Hydrocarbon deposition issue	Unusable	<b>2.1 – 4</b>	<b>0.16</b>
<b>PSA</b>	CO < 250 ppm	0.004-0.005	2 x 10 <sup>-5</sup>	<b>0.15-0.23</b>	0	0	Unusable	<b>2.1 – 4</b>	<b>0</b>
<b>PSA</b>	CO < 50 ppm	<0.004	2 x 10 <sup>-5</sup>	<b>0.15-0.23</b>	0	0	Unusable	<b>2.1 – 4</b>	<b>0</b>
<b>PSA</b>	CO < 1 ppm	<0.004	2 x 10 <sup>-5</sup>	<b>0.15-0.23</b>	0	0	20% voltage reduction + Inert impact	<b>2.1 – 4</b>	<b>0</b>
<b>PSA</b>	CO <0.2 ppm	<0.004	5-7 10 <sup>-5</sup>	<b>0</b>	0	0	Inert impact.	<b>0 (assume 2.1 – 4 in place of impact of inert gases)</b>	<b>0</b>
<b>PSA</b>	CO <0.2 ppm, N <sub>2</sub> <300 ppm	Negligible	5-7 10 <sup>-5</sup>	<b>0</b>	0	0	None	<b>0</b>	<b>0</b>
<b>PSA</b>	CO <0.2 ppm, Ar <300 ppm (ATR)	Negligible	5-7 10 <sup>-5</sup>	<b>0</b>	0	0	None	<b>0</b>	<b>0</b>

## 4.6 Cost Benefit Analysis

### 4.6.1 Framework

There are two key aspects to consider in determining the optimal purity specification for hydrogen in the grid. The first is to understand the level of purity considered acceptable and safe for hydrogen in the network, mainly relating to the level of carbon monoxide. This choice is informed by the analysis of the additional costs of production associated with decreasing levels of carbon monoxide, detailed in the executive summary of this report. The second is to understand the impact of the different purity levels on the cost to different hydrogen users, to determine whether an increased level of purity at the point of production could result in a reduction in the total system cost for a given mix of end-users of hydrogen.

In the previous section, the costs associated with the clean-up of impurities at the point of use were estimated, and the cost impacts of impurities for different end-uses were outlined. The cost impact of the impurities at the levels considered in this report were shown by Table 38 to only be significant for PEMFC.

We therefore determine, for each hydrogen grid purity standard, the indicative 'threshold' ratio of PEMFC hydrogen demand to combustion-based demand above which it is more cost-effective to produce hydrogen to the PEMFC standard rather than to undertake downstream purification.

The downstream clean-up costs are preliminary estimates, based upon the target costs of demonstration projects for pre-commercial technologies, and should be considered highly uncertain. Therefore, the threshold ratios evaluated should not be treated as exact but indicate the order of magnitude of PEMFC demand compared to fuel cell demand at which purifying to the fuel cell standard becomes economical.

The calculation steps to determine this threshold ratio are presented in Table 43.

The production costs from the Executive summary are re-framed in terms of the production savings compared to purifying to the ISO/DIS 14687 PEMFC standard, in order to allow for comparison with the additional downstream clean-up costs. Where a range of possible costs are present, the minimum plausible and maximum plausible cost saving compared to producing to the ISO/DIS PEMFC standard will be included. The minimum and maximum calculated downstream clean-up costs, estimated in Section 4.5.2, are also included.

The minimum plausible threshold ratio of PEMFC hydrogen demand to combustion hydrogen demand above which it is cheaper to produce hydrogen to the PEMFC standard, is calculated by dividing the minimum plausible production saving by the maximum plausible additional cost by the downstream clean-up compared to the PEMFC standard. The maximum value is calculated by dividing the maximum production saving by the minimum clean-up cost.

		Production cost compared to PEMFC spec(p/kWh)		Downstream cost compared to PEMFC standard (p/kWh)		Ratio FC/Combustion demand below which it is cheaper to purify to FC standard	
Purity	Purification Step	Min	Max	Min	Max	Min	Max
X ppm CO	Methanation					$\frac{\text{Min Production Saving}}{\text{Max Downstream Cost}}$	$\frac{\text{Max Production Saving}}{\text{Min Downstream Cost}}$

**Table 43: Table will be used to calculate the ratio of combustion : FC demand, below which it is cheaper to purify to ISO/DIS 14687 standard at the reformer**

Argon is only expected to be found if an ATR is used for hydrogen production. It was noted in Section 4.4.7 that the costs of removing Argon are artificially high in this model, due to the wasting of the PSA tail gas and the potential that argon may be more cheaply in the air separation unit of an ATR. The impact that argon may have on FC vehicles is also tentatively noted to be low, as it is mitigated by the periodic venting of the fuel cells. For this analysis, reference to meeting the PEMFC standard therefore refers to meeting the ISO/DIS 14687 standard for vehicle PEMFC for all impurities except for Argon.

In Section 4.4.7 it was noted that the range of additional costs associated with increasing purity levels at the point of production varies with the emissions restrictions applied to reformers, and so the cost benefit analysis will be framed in from this perspective.

### 4.6.2 Hydrogen demand scenarios

This section presents a range of illustrative hydrogen demand scenarios, and the value that the ratio of PEMFC hydrogen to combustion-based hydrogen would take in each case, for comparison with the threshold ratios calculated as described in the previous section.

Potential PEMFC demand for hydrogen may arise from either hydrogen combined heat and power (CHP) applications or from transport applications of hydrogen. For CHP applications, either SOFC or PEMFC could be used. SOFC are more tolerant to impurities than PEMFC. Projections of the uptake of either of these technologies have not been made for this analysis, as they would be highly uncertain and dependent upon the availability of hydrogen from the grid. Instead it is noted that the choice of hydrogen purity will likely influence the comparative uptake of PEMFC and SOFC: Producing hydrogen to the vehicle PEMFC standard will favour the uptake of PEMFC, while a lower purity will favour the uptake of SOFC.

For simplicity we will therefore consider only PEMFC demand for transport applications, in our reference scenarios and note again that these scenarios will be influenced by the availability of hydrogen in the grid and the future costs of purifying hydrogen taken from this grid for transport applications.

There is also a separate analysis, that would determine it is cost effective to use hydrogen delivered through the grid should be used for transport applications. This is not examined here, but it is noted that if hydrogen is not used for PEMFC in vehicles, or in PEMFC stationary CHP applications, then hydrogen should be produced to the lowest possible standard safe standard for combustions applications.

## Heating scenarios

The ECUK data [97] contains data on the energy consumption of the UK by sector and by fuel. In 2017, UK industry consumed 93 TWh of natural gas, the domestic sector 297 TWh and the services sector consumed 93 TWh, amounting to a total annual UK gas consumption of 483 TWh. This will be assumed as a starting scenario for the annual UK hydrogen demand. If the domestic sector only were to convert hydrogen, while alternative scenarios will be considered were each sector individually switches to using hydrogen.

Alternative scenarios with individual regions converting to utilising hydrogen as an energy source, especially those regions with easy access to carbon capture and storage facilities and hydrogen storage in salt caverns will be considered. BEIS has published Sub-national electricity and gas consumption statistics, by Regional and Local Authority [116] that includes the consumptions for these scenarios. If for example the North West only were to convert to using hydrogen, as the H21 NoE report [100] outlines plans for, the annual hydrogen demand would be 64 TWh and if only domestic consumption within the North West were switched the annual demand would be 38 TWh. If the North West, North East and Yorkshire and the Humber switched their total gas demand to hydrogen, the annual hydrogen demand would be 140 TWh.

## Transport scenarios

Element Energy has projections of annual sales of hydrogen, trains, cars, trucks and buses, determined for the UK H2 Mobility project and in consultation with industry. These projections were used to calculate the numbers of each of these categories in operation in 2030. Average mileages for each of these vehicles were then used to calculate the yearly hydrogen demand for PEMFC in these uses in 2030. The low, medium and high calculated uptake scenarios use 1.8 TWh, 3 TWh and 5 TWh of hydrogen each year. For reference, 660 TWh of energy was used by the transport in the UK in 2017 [97], and so these projections make up only a small fraction of total transport demand.

## Scenarios considered

There will be a correlation between the amount of the gas network switched to using hydrogen, and the amount of the transport hydrogen demand met by hydrogen from the grid compared to produce by electrolysers. If 10% of heating demand were replaced by hydrogen, a rough estimate would put 10% of the hydrogen used in transport as being provided by heat. Converting specific regions of the gas network to hydrogen is therefore assumed not to impact the ratio of PEMFC hydrogen demand to combustion hydrogen demand.

Instead, the conversions of different natural gas consuming sectors will be used to give example ratios of PEMFC to combustion hydrogen demand. The conversion of all sectors, domestic users only and industrial users only will be compared to the low, medium and high transport uptake scenarios.

The resulting values of the ratios of PEMFC and combustion use of hydrogen are outlined for each scenario in Table 44. The values that will be used for reference in the following analysis are emboldened.

Hy4Heat conversion Scenario	Transport Scenario	Heating Demand (TWh)	Transport Demand (TWh)	Ratio FC/Combustion ( $\times 10^{-3}$ )
All UK Gas	<b>Low</b>	<b>483</b>	<b>1.8</b>	<b>3.7</b>
	Central	483	3	6.2
	High	483	5	10.4
Domestic gas use only	Low	297	1.8	6.1
	<b>Central</b>	<b>297</b>	<b>3</b>	<b>10.1</b>
	High	297	5	16.8
Industrial gas use only	Low	93	1.8	19.4
	Central	93	3	32.3
	<b>High</b>	<b>93</b>	<b>5</b>	<b>53.8</b>

**Table 44: Comparison of heat and transport hydrogen demand scenarios**

### 4.6.3 Most stringent CO<sub>2</sub> emissions intensity (< 9 g/kWh)

If scope 1 carbon dioxide emissions of less than 9 g/kWh are required (a 95% saving compared to natural gas), then only an ATR with HP CC from the syngas and hydrogen as a fuel for the fired heater meets this requirement.

Table 45 summarises the range of cost savings associated with producing hydrogen to each level of purity instead of the ISO/DIS 14687 vehicle PEMFC standard calculated from the values in Section 4.4.7 and 4.5.4, and the additional downstream costs for the PEMFC summarised in Section 4.5.4. The threshold ratio of PEMFC hydrogen demand to combustion hydrogen demand above which it is cost-effective to purify to the ISO/DIS 14687 vehicle PEMFC instead of each purity level is also displayed.

Figure 51 displays these threshold ratios for each purity level studied. Several of the scenarios, highlighted in bold in Table 44, are marked as horizontal lines in the figure for comparison.

		Total Production cost compared to PEMFC (p/kWh)		Downstream cost compared to PEMFC (p/kWh)		Ratio PEMFC/Combustion demand above which it is more cost-effective to purify to the PEMFC standard	
Purity	Purification Step	Min	Max	Min	Max	Min (x10 <sup>-3</sup> )	Max (x10 <sup>-3</sup> )
CO < 50 ppm	Methanation	-0.066	0.055	2.41	4.39	15.1	Always more cost-effective to produce to PEMFC standard
CO < 250 ppm	PSA	-0.012	-0.030	2.25	4.23	2.9	13.2
CO < 50 ppm	PSA	-0.008	-0.021	2.25	4.23	1.9	9.4
CO < 1 ppm	PSA	-0.004	-0.011	2.25	4.23	0.9	4.8
CO < 0.2 ppm	PSA	-0.003	-0.008	2.1	4	0.9	3.7
						$\frac{\text{Min Production Saving}}{\text{Max Downstream Cost}}$	$\frac{\text{Max Production Saving}}{\text{Min Downstream Cost}}$

**Table 45: Cost savings for producing hydrogen to purity level compared to the ISO/DIS 14687 vehicle PEMFC standard, compared to the additional downstream costs for PEMFCs. If each purity level were selected to be the safe level of hydrogen, the ratio of PEMFC hydrogen demand compared to combustion hydrogen demand above which purifying to the fuel cell standard would be cheaper overall is calculated.**

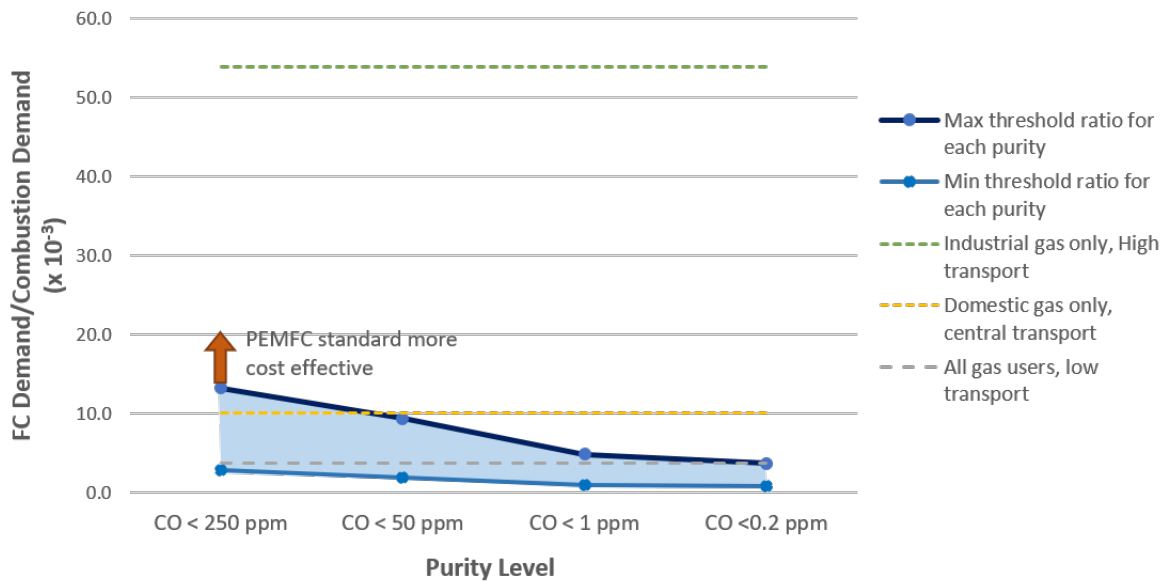

**Figure 50: For carbon emissions of <9 g/kWh. Ratio of PEMFC hydrogen demand to combustion hydrogen demand above which it makes sense to purify to the ISO vehicle PEMFC standard instead of the purity plotted. Scenario values for this ratio are marked with dashed lines. If the dashed line of a scenario lies above the plotted point, then it is more cost effective to purify to the PEMFC standard than the purity of that plotted point.**

Figure 52 demonstrates that in combining the ranges of values for production costs and clean-up costs, a very wide range of plausible ratios of PEMFC to combustion demand, above which it makes sense to purify to the PEMFC standard is found. The figure also demonstrates that the indicative scenario ratios for PEMFC to combustion demand are of the same order of magnitude as the ratios above which it may be cost-effective to produce to the vehicle PEMFC standard.

If the costs of purification at the point of use were to be significantly lower than the estimates determined earlier in this report, then producing hydrogen to a low purity would be more cost-effective. If the costs were to be higher than anticipated producing hydrogen to a higher standard would be cost-effective.

#### 4.6.4 Less stringent CO<sub>2</sub> emissions intensity (< 20 g/kWh)

If scope 1 carbon dioxide emissions of less than 20 g/kWh are required (~90% emission saving compared to natural gas), then an SMR, with both HP CC from the syngas and LP CC from the fired heater flue gas, can be used to produce hydrogen as well as the ATR using hydrogen as a fuel for the fired heater.

Table 46 summarises the range of cost savings associated with producing hydrogen to each level of purity instead of the ISO/DIS 14687 vehicle PEMFC standard calculated from the values in Section 4.4.7 and 4.5.4, and the additional downstream costs for the PEMFC summarised in Section 4.5.4. The ratio of PEMFC hydrogen demand to combustion hydrogen demand above which it is economical to purify to the ISO/DIS 14687 vehicle PEMFC instead of each purity level is also displayed

Figure 53 displays these ratios on a graph, alongside the PEMFC and combustion ratios associated with the scenarios outlined in Table 44.



		Total Production cost compared to PEMFC (p/kWh)		Downstream cost compared to PEMFC (p/kWh)		Ratio PEMFC/Combustion demand above which it is more cost-effective to purify to the PEMFC standard	
Purity	Purification Step	Min	Max	Min	Max	Min (x10 <sup>-3</sup> )	Max (x10 <sup>-3</sup> )
CO < 250 ppm	PSA/Methanation	-0.012	-0.096	2.25	4.23	2.8	171
CO < 50 ppm	PSA/Methanation	-0.008	-0.071	2.25	4.23	1.9	183
CO < 1 ppm	PSA	-0.004	-0.037	2.25	4.23	0.9	16
CO < 0.2 ppm	PSA	-0.003	-0.010	2.1	4	0.9	4
						$\frac{\text{Min Production Saving}}{\text{Max Downstream Cost}}$	$\frac{\text{Max Production Saving}}{\text{Min Downstream Cost}}$

**Table 46: Cost savings for producing hydrogen to purity level compared to the ISO/DIS 14687 vehicle PEMFC standard, compared to the additional downstream costs for PEMFCs. If each purity level were selected to be the safe level of hydrogen, the ratio of PEMFC hydrogen demand compared to combustion hydrogen demand above which purifying to the fuel cell standard would be cheaper overall is calculated.**

Figure 51 shows that the ranges of ratio of PEMFC to combustion demand at which purifying to the fuel cell standard is cost effective is now significantly higher than those found for emissions of less than 9 g/kWh, especially for higher carbon monoxide levels. This extra range is due two effects.

The first effect is that there are now two reforming options for producing hydrogen, on which a PSA and methanation have different impacts. The second is due to the inclusion of methanation as a cheaper option than a PSA for reducing carbon monoxide in hydrogen produced by an SMR to 50 ppm.

In calculating the cost saving of using methanation to reach 50 ppm CO instead of a PSA to reach the PEMFC standard, two uncorrelated ranges of potential costs for hydrogen purification are compared. One range is from the range of costs associated with using methanation for purification and one using a PSA, comparing these two ranges gives an increased range of cost savings. The further comparison to the estimates of downstream clean-up cost in order to find the PEMFC to combustion hydrogen demand ratio, then further increases the range of plausible values for hydrogen production.

For an SMR at 250 or 50 ppm CO, there is no scenario considered in which it makes sense to purify to the FC standard. However, an ATR is still a viable option for producing hydrogen, in which case the costs associated with increasing purity are reduced and the indicative scenario ratios for PEMFC to combustion demand are of the same order of magnitude as the ratios above which it may be economical to produce to the vehicle PEMFC standard.

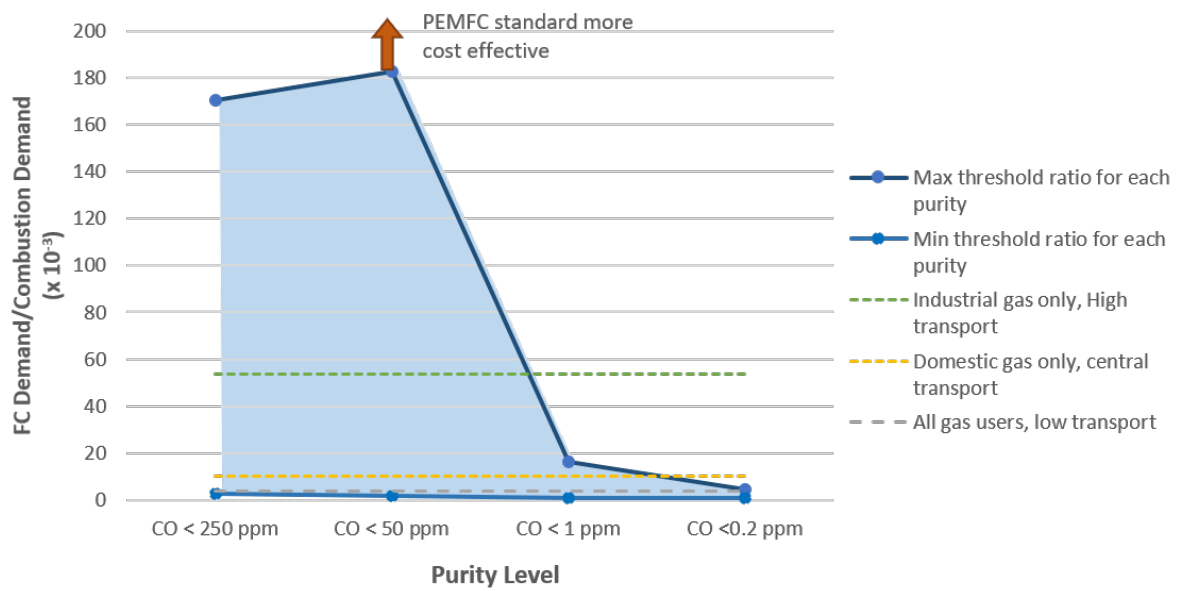

**Figure 51: For CO<sub>2</sub> emissions <20 g/kWh, threshold ratios of PEMFC hydrogen demand to combustion hydrogen demand above which it makes sense to purify to the ISO vehicle PEMFC standard instead of the purity plotted. Scenario values for this ratio are marked with dashed lines. If the dashed line of a scenario lies above the plotted point, then it is more cost effective to purify to the PEMFC standard than the purity of that plotted point.**

## 5 CONCLUSIONS

conclusions from this report are detailed below

1. This report has focused on hydrogen production and trace impurities that results in a range of purity characteristics. This has informed the required clean-up technology and this in turn has enabled a draft purity specification to be developed.
2. The literature review undertaken suggests that there is already a lot of useful information or guidance on quality recommendations for hydrogen used for heating, and the definition of the purity standard has been formulated on this basis.
3. The specification has been shared with a number of key stakeholders a broad range of stakeholders including producers, network operators, equipment designers, appliance manufacturers and technical consultants) and responses collated. These are further informing the debate on hydrogen purity, and further information is being sought to support the evaluation of the purity specification.
4. The production process and options for clean-up have undergone a cost benefit study using selected target scenarios. It can be seen that for some of the scenarios (those with higher hydrogen transport demand and lower heat/combustion hydrogen demand) the ratio of PEMFC hydrogen demand to combustion-based hydrogen demand is close to or within the range in which it may be more cost-effective at the system level for the grid to deliver hydrogen at ISO/DIS 14687 standard for vehicle PEMFC, rather than at a lower purity level.

This outcome is more likely in the case of a more stringent CO<sub>2</sub> emissions intensity requirement. However, it must be recognised that pick-up of contamination in the distribution pipeline network may be a factor in the final delivered purity.

In the counter view, there are several cases where the overall system cost is lower when hydrogen is delivered at a lower purity level. Within the range of uncertainties found, we can therefore identify plausible scenarios for with it is more cost effective to purify hydrogen to low purity and others where a high purity is cost effective. The lower purity specification for delivered hydrogen would mean that additional clean-up may be required at point of use for several utilisation technologies.

5. The two most significant uncertainties that need to be considered are the costs of purification at the point of use for PEMFC applications, and the future demands for hydrogen from the grid used in PEMFC applications and combustion applications. Both will be difficult to address until there is greater certainty on the potential replacement of natural gas with hydrogen, giving the incentive to commercialise point of use purification technologies and a clearer picture of the likely PEMFC and combustion demand for hydrogen in the grid.
6. These uncertainties mean that no firm conclusions can be drawn at this stage on the most cost-effective level of purity for hydrogen delivered through the grid. This cost-benefit analysis, however, provides insight into the circumstances in which different levels of purity of hydrogen in the grid may lead to the most cost-effective outcome, and highlights the factors that could influence the optimal purity specification.

## APPENDIX A: GAS QUALITY SPECIFICATIONS

Content or characteristic	Value
Hydrogen sulphide content	$\leq 5 \text{ mg m}^{-3}$
Total sulphur content (including H <sub>2</sub> S)	$\leq 50 \text{ mg m}^{-3}$
Hydrogen content	$\leq 0.1\%$ (molar)
Oxygen content	$\leq 0.2\%$ (molar)
Impurities	Shall not contain solid or liquid material which may interfere with the integrity or operation of pipes or any gas appliance (within the meaning of regulation 2(1) of the 1994 Regulations) which a consumer could reasonably be expected to operate
Hydrocarbon dewpoint and water dewpoint	Shall be at such levels that they do not interfere with the integrity or operation of pipes or any gas appliance (within the meaning of regulation 2(1) or the 1994 Regulations) which a consumer could reasonably be expected to operate
Wobbe number (WN)	$47.20 \text{ MJ m}^{-3} \leq \text{WN} \leq 51.41 \text{ MJ m}^{-3}$
Incomplete combustion factor (ICF)	$\leq 0.48$
Sooting index (SI)	$\leq 0.60$

**Table 47: Gas quality specifications according to GS(M)R 1996**

Parameter	Description	Units	Minimum	Maximum	Recommended implementation date
WI	Wobbe index	kWh m <sup>-3</sup>	13.60	15.81	01/10/2010
D	Relative density	m <sup>3</sup> m <sup>-3</sup>	0.555	0.700	01/10/2010
S	Total sulphur	mg m <sup>-3</sup>		30	01/10/2006
H <sub>2</sub> S + COS	Hydrogen sulphide + carbonyl sulphide	mg m <sup>-3</sup>		5	01/10/2006
RSH	Mercaptans	mg m <sup>-3</sup>		6	01/10/2006
O <sub>2</sub>	Oxygen	mol %		0.01*	01/10/2010
CO <sub>2</sub>	Carbon dioxide	mol %		2.5	01/10/2006
H <sub>2</sub> O DP	Water dew point	°C at 7000 kPa		-8	see note **
HC DP	Hydrocarbon dew point	°C at 1 - 7000 kPa		-2	01/10/2006

\*EASEE gas have organised an oxygen measurement survey, which by end of 2005 will examine the maximum feasible limit equal to or at an alternative specified value below 0.01 mol%.

\*\*At certain cross border points, less stringent values are used than defined in this Common Business Practice (CBP). For these cross-border points, these values can be maintained, and the relevant producers, shippers and transporters should examine together how the CBP value can be met in the long run. At all other cross border points, this value can be adopted by 1<sup>st</sup> October 2006.

**Table 48: Gas specification for natural gas quality proposed in EASEE-gas**

Constituent	Chemical formula	Limits	Laboratory test methods to consider and under development	Minimum analytical detection limit
Hydrogen fuel index	H <sub>2</sub>	> 99.97%		
Total allowable non-hydrogen, non-helium, non-particulate constituents listed below		100		
<b>Acceptable limit of each individual constituent</b>				
Water	H <sub>2</sub> O	5	ASTM D7653-10, ASTM D7649-10	0.12
Total hydrocarbons (C <sub>1</sub> basis)		2	ASTM D7675-11	0.1
Oxygen	O <sub>2</sub>	5	ASTM D7649-10	1
Helium		300	ASTM D1945-03	100
Nitrogen, Argon	N <sub>2</sub> , Ar	100	ASTM D7649-10	5
Carbon dioxide	CO <sub>2</sub>	2	ASTM D7649-10, ASTM D7653-10	0.1
Carbon monoxide	CO	0.2	ASTM D7653-10	0.01
Total sulphur		0.004	ASTM D7652-11	0.00002
Formaldehyde	HCHO	0.01	ASTM D7653-10	0.01
Formic acid	HCOOH	0.2	ASTM D7550-09, ASTM D7653-10	0.02
Ammonia	NH <sub>3</sub>	0.1	ASTM D7653-10	0.02
Total halogenates		0.05	(Work item 23815)	0.01
Particulate concentration		1 mg kg <sup>-1</sup>	ASTM D7650-10, ASTM D7651-10	0.005 mg kg <sup>-1</sup>

**Table 49: Hydrogen quality specification from SAE J2719 (all levels specified in  $\mu\text{mol mol}^{-1}$  unless stated otherwise)**

Constituent	Level
Carbon monoxide (CO)*	< 15 $\mu\text{mol mol}^{-1}$
Methane (CH <sub>4</sub> )	< 100 $\mu\text{mol mol}^{-1}$
Carbon dioxide (CO <sub>2</sub> )	< 10 $\mu\text{mol mol}^{-1}$
Hydrogen fuel index (minimum mole fraction)	> 99.98 %

\* The authors indicate that PEM fuel cells can operate at up to 15  $\mu\text{mol mol}^{-1}$

**Table 50: Hydrogen purity specifications proposed in Leeds City Gate H21 final report**

<b>Constituent</b>	<b>Characteristics</b>
Hydrogen fuel index (minimum mole fraction)	99.97%
Total non-hydrogen gases	300 $\mu\text{mol mol}^{-1}$
<b>Maximum concentration of individual contaminants</b>	
Water (H <sub>2</sub> O)	5 $\mu\text{mol mol}^{-1}$
Total hydrocarbons (THC) (Excluding Methane)	2 $\mu\text{mol mol}^{-1}$
Methane (CH <sub>4</sub> )	100 $\mu\text{mol mol}^{-1}$
Oxygen (O <sub>2</sub> )	5 $\mu\text{mol mol}^{-1}$
Helium (He)	300 $\mu\text{mol mol}^{-1}$
Nitrogen (N <sub>2</sub> )	300 $\mu\text{mol mol}^{-1}$
Argon (Ar)	300 $\mu\text{mol mol}^{-1}$
Carbon dioxide (CO <sub>2</sub> )	2 $\mu\text{mol mol}^{-1}$
Carbon monoxide (CO)	0.2 $\mu\text{mol mol}^{-1}$
Total sulphur compounds (H <sub>2</sub> S basis)	0.004 $\mu\text{mol mol}^{-1}$
Formaldehyde (HCHO)	0.2 $\mu\text{mol mol}^{-1}$
Formic acid (HCOOH)	0.2 $\mu\text{mol mol}^{-1}$
Ammonia (NH <sub>3</sub> )	0.1 $\mu\text{mol mol}^{-1}$
Halogenated compounds (Halogenate ion basis)	0.05 $\mu\text{mol mol}^{-1}$
Maximum particulates concentration	1 mg kg <sup>-1</sup>
<p>For the constituents that are additive, such as total hydrocarbons and total sulphur compounds, the sum of the constituents shall be less than or equal to the acceptable limit.</p>	
<p><sup>a</sup> The hydrogen fuel index is determined by subtracting the "total non-hydrogen gases" in this table, expressed in mole percent, from 100 mol percent.</p> <p><sup>b</sup> Total hydrocarbons include oxygenated organic species. Total hydrocarbons shall be measured on a carbon basis (<math>\mu\text{molC mol}^{-1}</math>).</p> <p><sup>c</sup> Total of CO, HCHO, HCOOH shall not exceed 0.2 <math>\mu\text{mol mol}^{-1}</math>.</p> <p><sup>d</sup> All halogenated compounds which could potentially be in the hydrogen gas (for example, hydrogen chloride (HCl), and organic halides (R-X)) should be determined according to the hydrogen quality assurance discussed in Clause 6 of EN 17124 and the sum shall be less than 0.05 <math>\mu\text{mol mol}^{-1}</math>.</p>	

**Table 51: Fuel quality specifications for PEM fuel cell road vehicle applications in EN 17124**

Type	Grade	Category	Applications
I Gas	A	-	Gaseous hydrogen; Internal combustion engines for transportation; Residential/commercial combustion appliances (e.g. boilers, cookers and similar applications)
	B	-	Gaseous hydrogen; Industrial fuel for power generation and heat generation except PEM fuel cell applications
	C	-	Gaseous hydrogen; Aircraft and space-vehicle ground support systems except PEM fuel cell applications
	D	-	Gaseous hydrogen; PEM fuel cells for road vehicles
	E	PEM fuel cells for stationary appliances	
		1	Hydrogen based fuel; High efficiency/low power applications
2		Hydrogen based fuel; High power applications	
	3	Gaseous hydrogen; High power/high efficiency applications	
II Liquid	C	-	Aircraft and space-vehicle on-board propulsion and electric energy requirements; Off-road vehicles
	D	-	PEM fuel cells for road vehicles
III Slush	-	-	Aircraft and space-vehicle on-board propulsion
<p>PEM: Proton Exchange Membrane</p> <p>Note 1 – Grade D may be used for other fuel cell applications for transportation including forklifts and other industrial trucks if agreed upon between supplier and customer.</p> <p>Note 2 – Grade D may be used for PEM fuel cell stationary appliances alternative to Grade E category 3.</p> <p>Note 3 – It should be recognised that biological sources of hydrogen can contain additional constituents (e.g. siloxanes or mercury) that can affect the performance of the various applications, particularly PEM fuel cells, however these are not included in most of the following specifications due to insufficient information.</p>			

**Table 52: Classification grades of hydrogen in ISO/FDIS 14687**

<b>Constituents (assay)</b>	<b>Type I, Type II Grade D</b>
Hydrogen fuel index (minimum mole fraction)	99.97%
Total non-hydrogen gases	300 $\mu\text{mol mol}^{-1}$
<b>Maximum concentration of individual contaminants</b>	
Water (H <sub>2</sub> O)	5 $\mu\text{mol mol}^{-1}$
Total hydrocarbons except methane (C1 equivalent)	2 $\mu\text{mol mol}^{-1}$
Methane (CH <sub>4</sub> )	100 $\mu\text{mol mol}^{-1}$
Oxygen (O <sub>2</sub> )	5 $\mu\text{mol mol}^{-1}$
Helium (He)	300 $\mu\text{mol mol}^{-1}$
Nitrogen (N <sub>2</sub> )	300 $\mu\text{mol mol}^{-1}$
Argon (Ar)	300 $\mu\text{mol mol}^{-1}$
Carbon dioxide (CO <sub>2</sub> )	2 $\mu\text{mol mol}^{-1}$
Carbon monoxide (CO)	0.2 $\mu\text{mol mol}^{-1}$
Total sulphur compounds (S1 equivalent)	0.004 $\mu\text{mol mol}^{-1}$
Formaldehyde (HCHO)	0.2 $\mu\text{mol mol}^{-1}$
Formic acid (HCOOH)	0.2 $\mu\text{mol mol}^{-1}$
Ammonia (NH <sub>3</sub> )	0.1 $\mu\text{mol mol}^{-1}$
Halogenated compounds (Halogen ion equivalent)	0.05 $\mu\text{mol mol}^{-1}$
Maximum particulate concentration	1 mg kg <sup>-1</sup>

**Table 53: Fuel quality specification for PEM fuel cell road vehicle application in ISO/FDIS 14687**



Constituents (assay)	Type I, Grade E		
	Category 1	Category 2	Category 3
Hydrogen fuel index (minimum mole fraction)	50 %	50 %	99.9 %
Total non-hydrogen gases (maximum mole fraction)	50 %	50 %	0.1 %
Water (H <sub>2</sub> O)	Non-condensing at all ambient conditions		
<b>Maximum concentration of individual contaminants</b>			
Total hydrocarbons except methane (C <sub>1</sub> equivalent)	10 µmol mol <sup>-1</sup>	2 µmol mol <sup>-1</sup>	2 µmol mol <sup>-1</sup>
Methane (CH <sub>4</sub> )	5 %	1 %	100 µmol mol <sup>-1</sup>
Oxygen (O <sub>2</sub> )	200 µmol mol <sup>-1</sup>	200 µmol mol <sup>-1</sup>	50 µmol mol <sup>-1</sup>
Sum of nitrogen (N <sub>2</sub> ), argon (Ar) and helium (He) (mole fraction)	50 %	50 %	0.1 %
Carbon dioxide (CO <sub>2</sub> )	Included in total non-hydrogen gases	Included in total non-hydrogen gases	2 µmol mol <sup>-1</sup>
Carbon monoxide (CO)	10 µmol mol <sup>-1</sup>	10 µmol mol <sup>-1</sup>	0.2 µmol mol <sup>-1</sup>
Total sulphur compounds (S1 equivalent)	0.004 µmol mol <sup>-1</sup>	0.004 µmol mol <sup>-1</sup>	0.004 µmol mol <sup>-1</sup>
Formaldehyde (HCHO)	3.0 µmol mol <sup>-1</sup>	0.2 µmol mol <sup>-1</sup>	0.2 µmol mol <sup>-1</sup>
Formic acid (HCOOH)	10 µmol mol <sup>-1</sup>	0.2 µmol mol <sup>-1</sup>	0.2 µmol mol <sup>-1</sup>
Ammonia (NH <sub>3</sub> )	0.1 µmol mol <sup>-1</sup>	0.1 µmol mol <sup>-1</sup>	0.1 µmol mol <sup>-1</sup>
Halogenated compounds (Halogen ion equivalent)	0.05 µmol mol <sup>-1</sup>	0.05 µmol mol <sup>-1</sup>	0.05 µmol mol <sup>-1</sup>
Maximum particulate concentration	1 mg kg <sup>-1</sup>	1 mg kg <sup>-1</sup>	1 mg kg <sup>-1</sup>
Maximum particle diameter	75 µm	75 µm	75 µm

**Table 54: Fuel quality specifications for PEM fuel cell stationary applications in ISO/FDIS 14687**

Constituents (assay)	Type I			Type II	Type III
	Grade A	Grade B	Grade C	Grade C	
Hydrogen fuel index (minimum mole fraction, %)	98.0 %	99.90 %	99.995 %	99.995 %	99.995 %
<i>Para</i> -hydrogen (minimum mole fraction, %)	NS	NS	NS	95.0 %	95.0 %
<b>Impurities</b> (maximum content)					
Total gases	20 000 $\mu\text{mol mol}^{-1}$	1 000 $\mu\text{mol mol}^{-1}$	50 $\mu\text{mol mol}^{-1}$	50 $\mu\text{mol mol}^{-1}$	
Water (H <sub>2</sub> O) (mole fraction, %)	Non-condensing at all ambient conditions		c	c	
Total hydrocarbon	100 $\mu\text{mol mol}^{-1}$	Non- condensing at all ambient conditions	c	c	
Oxygen (O <sub>2</sub> )	b	100 $\mu\text{mol mol}^{-1}$	d	d	
Argon (Ar)	b		d	d	
Nitrogen (N <sub>2</sub> )	b	400 $\mu\text{mol mol}^{-1}$	c	c	
Helium (He)			39 $\mu\text{mol mol}^{-1}$	39 $\mu\text{mol mol}^{-1}$	
Carbon dioxide (CO <sub>2</sub> )			e	e	
Carbon monoxide (CO)	1 $\mu\text{mol mol}^{-1}$		e	e	
Mercury (Hg)		0.004 $\mu\text{mol mol}^{-1}$			
Sulphur (S)	2.0 $\mu\text{mol mol}^{-1}$	10 $\mu\text{mol mol}^{-1}$			
Permanent particulates	g	f	f	f	
Density					f
<p><sup>a</sup> The hydrogen fuel index is determined by subtracting the "total non-hydrogen gases" expressed in mole percent, from 100 mole percent.</p> <p><sup>b</sup> Combined water, oxygen, nitrogen and argon; maximum mole fraction of 1.9 %.</p> <p><sup>c</sup> Combined nitrogen, water and hydrocarbon: max. 9 <math>\mu\text{mol mol}^{-1}</math>.</p> <p><sup>d</sup> Combined oxygen and argon: max. 1 <math>\mu\text{mol mol}^{-1}</math>.</p> <p><sup>e</sup> Total CO<sub>2</sub> and CO: max. 1 <math>\mu\text{mol mol}^{-1}</math>.</p> <p><sup>f</sup> To be agreed between supplier and customer.</p> <p><sup>g</sup> The hydrogen shall not contain dust, sand, dirt, gums, oils or other substances in an amount sufficient to damage the fuelling station equipment or the vehicle (engine) being fuelled.</p>					

**Table 55: Fuel quality specification for applications other than PEM fuel cell road vehicle and stationary applications in ISO/FDIS 14687**



<b>Production process</b>	<b>Hydrogen purity</b>
Steam methane reforming	> 97.5 %
Auto thermal reforming	> 98.3 %
Gasification (coal)	> 99.9 %

**Table 56: Hydrogen purity provided by different production processes**

## APPENDIX B: DEMONSTRATION OF HYDROGEN PRODUCTION FROM FOSSIL FUEL PLANTS WITH CCUS

A summary of the plants producing hydrogen from fossil fuels with CCUS is presented in the IEAGHG technical review [41] and by Volsund et al. [31].

**Port Jerome (Air Liquide, France)** - This plant is summarised in an Air Liquide Publication [73]. In this plant, CO<sub>2</sub> is captured from the PSA off-gas using their CRYOCAPT<sup>™</sup> system which combines a membrane and a cryogenic separation technology. The off-gas is compressed, passed through a cryogenic system to separate the CO<sub>2</sub> and then uses a membrane to separate hydrogen from the non-liquified gas to be returned to the PSA. The waste product from the membrane is then combusted to heat the SMR. The return of hydrogen to the PSA increases the hydrogen production by between 10-20%. The process flow diagram for this system is shown in Figure 52.

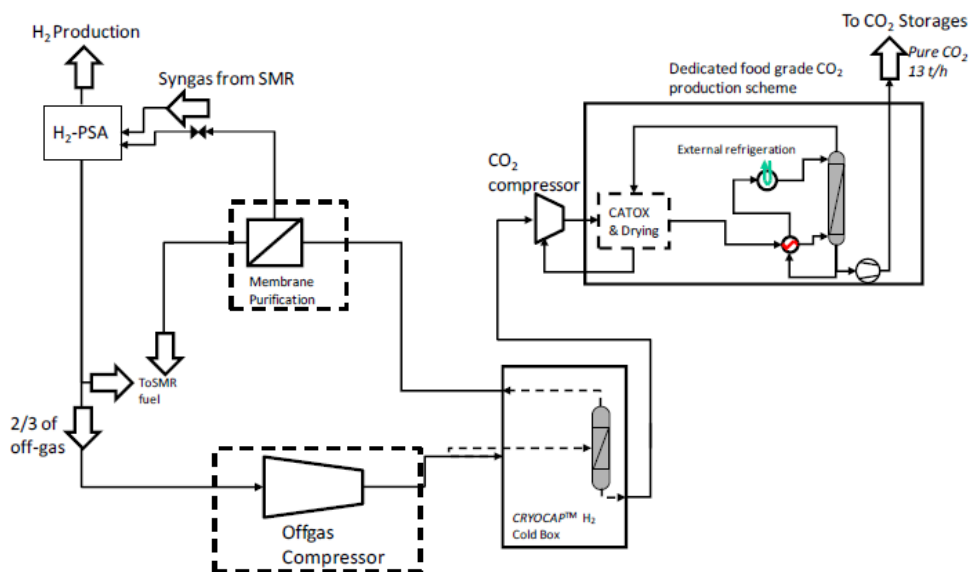

**Figure 52: Process flow diagram for the Port Jerome Plant**

**Port Arthur (Air Products, Texas)** - This plant captures CO<sub>2</sub> directly from the syngas produced by two existing SMRs with a combined capacity of 250,000 Nm<sup>3</sup>/h. CO<sub>2</sub> is separated by a vacuum PSA designed to remove CO<sub>2</sub> and then the CO<sub>2</sub> is dried and compressed to be used for enhanced oil recovery. The plants have a 30 MW cogeneration unit to provide steam to the SMR, operate the VSA and compress the CO<sub>2</sub>.

**Quest (Shell, Canada)** - This plant captures CO<sub>2</sub> from three SMRs, with total capacity of 37.4 t/h (1.2 GW), directly from the syngas using an amine-based chemical absorption (Shell ADIPX) in Saskatchewan, Alberta, Canada. The plant imports a total of 21 MW power including the CO<sub>2</sub> compression.

**Tomakomai (Ministry of Economy, Trade and Industry, Japan)** - This plant captures CO<sub>2</sub> from the PSA off-gas of a 200 MW (6 t/h) hydrogen production plant in an oil refinery, using an amine-based solvent. The capture is not conducted upstream of the PSA due to area restrictions in the refinery. Pre-capture the off-gas is compressed so that the CO<sub>2</sub> partial pressure is the same as in the PSA upstream gas. The plant imports 0.49 MW for the amine pumps (ignoring the CO<sub>2</sub> compression), the amine reboiler duty is 0.92 GJ/tonne-CO<sub>2</sub> and total cost of CO<sub>2</sub> capture is 1.22 GJ/tonne.

## APPENDIX C: UK PRODUCTION SITES

Sources used: Roads2HyCom [44] and H2tools data for merchant hydrogen capacities in Europe [89], plus internal element energy knowledge on electrolyser.

Site name	Plant owner	Source of H <sub>2</sub>	Capacity (kg/day)
Greenock	Air Products		900
Purfleet	Air Products	SMR	1,079
Sandbach	Air Products	Byproduct	1,079
Wilton	Air Products	SMR	1,349
Llanwern	Air Products	(Mix from British Steel)	5,666
Barry	Linde (BOC)	SMR	1,079
Castleford	Linde (BOC)	SMR	2,339
Newport	Linde (BOC)		2,159
Margam, Port Talbot	Linde (BOC)	SMR	2,788
Teesside Hydrogen Plant	Linde (BOC)	SMR	88,504
St. Helens	Linde (BOC)	SMR	4,947
Trostre	Linde (BOC)		3,454
Esso Petroleum Company Ltd	Esso Petroleum Company Limited	Refinery	137,523
Lindsey Oil Refinery	Total Lindsey Oil Refinery Limited	Refinery	70,155
Humber Refinery	Phillips 66 Limited	Refinery	44,522
Haltermann Carless UK Ltd - Harwich Refinery	Haltermann Carless UK Ltd	Refinery	347
Grangemouth Refining	PETROINEOS Manufacturing Scotland Limited	Refinery	128,618
Newport Wafer Fab Ltd	Newport Wafer Fab Ltd	Refinery	357
Valero Energy Ltd	Valero Energy Ltd	Refinery	20,417
Stanlow Manufacturing Complex	Essar Oil UK Ltd	Refinery	-
Eastham Refinery Ltd	Eastham Refinery Limited	Refinery	-
Runcorn Halochemicals Manufacturing	INOVYN ChlorVinyls Limited	Byproduct	52,167
Ellesmere Port Innospec Ltd.	Innospec Limited	Byproduct	2,069
Fife Ethylene Plant	ExxonMobil Chemical Limited	Byproduct	37,416
BP Chemicals Ltd, Hull	BP Chemicals Ltd	Byproduct	51,807
Wilton Olefins 6 (Cracker)	Sabir UK Petrochemicals Limited	Byproduct	-
North tees Aromatics	Sabir UK Petrochemicals Limited	Byproduct	-
Honda, Swindon	BOC	Electrolyser	200
Kittybrewster, Aberdeen	BOC	Electrolyser	360
AMP, Sheffield	ITM Power	Electrolyser	80
NPL, Teddington	ITM Power	Electrolyser	80
CEME, Rainham	ITM Power	Electrolyser	80
Shell, Cobham, London	ITM Power	Electrolyser	80
Tullos, Aberdeen	Hydrogenics	Electrolyser	80

Site name	Plant owner	Source of H <sub>2</sub>	Capacity (kg/day)
Shell, Gatwick, London	ITM Power	Electrolyser	80
Shell, Beaconsfield	ITM Power	Electrolyser	80

**Table 57: List of UK Production Sites**

## APPENDIC D: HYDROGEN SAMPLING DATA

Impurity data in hydrogen sampled by the HyCORA project is shown in Figure 53, Figure 54 and Figure 55. Impurity data for hydrogen sampled by the EMPIR project is displayed in Figure 57.

ID	Tol	HY-1	HY-2	HY-3	HY-4	HY-5	HY-6	HY-7	HY-8
<b>Feed</b>		WE	SMR	SMR/BIO	SMR/BIO	WE	CA	WE	WE
<b>Storage</b>		C	C	L	L	C	C	C	C
<b>On-site</b>		Y	N	N	N	Y	N	N	N
H <sub>2</sub> O	5	< 1	< 1	< 1	< 1	< 1	2.9	< 1	< 1
THC (C1)	2	0.049	0.17	0.04	0.11	0.14	0.55	0.1	0.048
O <sub>2</sub>	5	3.3	3.5	1.7	2.3	2.4	4.1	5.7	1.1
He	300	< 10	< 10	< 10	54	< 10	< 10	< 10	< 10
N <sub>2</sub> + Ar	100	24	74	10	10	14	1444	34	34
CO <sub>2</sub>	2	< 0.2	< 0.2	< 0.2	< 0.2	0.20	0.43	< 0.2	< 0.2
CO	0.2	0.0040	0.0033	0.001503	0.000661	0.00096	0.0037	0.0014	0.0015
HCHO	0.01	< 0.001	< 0.001	< 0.001	< 0.001	< 0.001	< 0.001	< 0.001	< 0.001
CHOOH	0.2	< 0.005	< 0.005	< 0.005	< 0.005	< 0.005	< 0.005	< 0.005	< 0.005
NH <sub>3</sub>	0.1	< 0.001	< 0.001	< 0.001	< 0.001	< 0.001	< 0.001	< 0.001	< 0.001
TS	0.004	0.000076	0.000051	0.000098	0.00011	0.00008	0.0004	0.00033	0.0001
TX	0.05	0.020	0.013	0.022	0.019	0.018	0.019	0.019	0.028
FI (%)	99.97	99.9973	99.9923	99.9988	99.9934	99.9983	99.8551	99.9960	99.9965

Figure 53: Impurity data for hydrogen sampled at hydrogen refuelling stations by the 1st HyCORA measurement campaign. [57]

Feedstock	SMR	SMR	SMR	SMR	SMR	WE	WE	WE	WE	WE*		
Storage	C	L	L	L	L	C	C	C	C	C		
On-site?	N	N	N	N	N	Y	N	N	N	N		
ppm mol	HY-2	HY-3	HY-4	HY-5	HY-6	HY-7	HY-8	HY-9	HY-10	HY-12	LOD	Tol
Commissioned	2013	2015	2015	2015	2015	2016	2016	2015	2015	2016		
Fuel Index	99.99396	99.99750	99.99259	99.99634	99.99371	99.99384	99.99199	99.96163	99.95574	99.99180		99.97
H <sub>2</sub> O		1.5									1	5
THC (C1)	0.12	0.04	0.13	0.07	0.36	0.30	0.84	0.42	5.1	0.88		2
O <sub>2</sub>	4.9	5.0	4.9	11	5.7	5.2	4.1	5.4	13	5.4	1	5
He			51		40						10	300
N <sub>2</sub> & Ar	56	19	16	26	18	56	75	378	419	76		100
N <sub>2</sub>	55	19	16	26	18	56	75	378	416	76	5	
Ar	0.57								3.1		0.4	
CO <sub>2</sub>									5.7		0.1	2
CO	0.0047	0.0011	0.0040	0.0014	0.0048	0.0032	0.0025	0.0016	0.015	0.0023	0.0005	0.2
TS	0.000026	0.000024	0.000020	0.000017	0.000032	0.000034	0.000039	0.000013	0.00011	0.00015		0.004
HCHO											0.001	0.01
HCOOH											0.001	0.2
NH <sub>3</sub>											0.01	0.1
TH	0.00048	0.0019	0.00042	< 0.001	0.00048	0.026	0.015	0.023	0.0033	0.0049		0.05

Figure 54: Impurity data for hydrogen sampled at hydrogen refuelling stations by the 2nd HyCORA measurement campaign. Note that Hy-12 is a repeat sample of Hy-8. [58]

Feedstock	WE	WE	WE	CA	WE	WE	WE	WE	WE*	WE		
Storage	C	C	C	C	C	n/a	n/a	n/a	C	n/a		
On-site?	n/a	n/a	n/a	n/a	N	N	N	N	n/a	N		
ppm mol	HY-1	HY-2	HY-3	HY-4	HY-5	HY-6	HY-7	HY-8	HY-9	HY-10	LOD	Tol
Fuel Index	99,99894	99,999	99,99803	99,94969	99,99539	99,99457	99,99719	99,99866	99,99781	99,99714	0	99,97
H2O	0	0	0	1,3	0	0	0	0	0	0	1	5
THC (C1)	0,22	1,7	1	47	1,2	0,27	0,42	0,15	0,8	0,72	0	2
O2	0	0	4,1	1,8	3,1	4,8	3,4	0	4,2	4,4	1	5
He	10	0	0	0	0	0	0	13	0	0	10	300
N2 & Ar	0	8,3	15	452,3	41,48	49,41	24	0	17	23,4	0	100
N2	0	8,3	15	448	41	49	24	0	17	23	5	0
Ar	0	0	0	4,3	0,48	0,41	0	0	0	0,4	0,4	0
CO2	0	0	0	0,37	0	0	0,36	0	0	0,2	0,1	2
CO	0,0022	0,001	0,00087	0,0093	0,003	0,0017	0,0015	0,0027	0,0035	0,0023	0,0005	0,2
TS	0,000016	0,00001	0,000016	4,2E-06	0,000015	0,000016	0,00002	0,000022	0,000017	0,000018	0	0,004
HCHO	0	0	0	0	0	0	0	0	0	0	0,001	0,001
CH3COOH	0	0	0	0	0	0	0	0	0	0	0,001	0,2
NH3	0	0	0	0	0	0	0	0	0	0	0,01	0,1
TH	0,00067	0,0026	0,0037	0,0062	0,0028	0,0035	0,002	0,0038	0,0042	0,01	0	0,05

Figure 55: Impurity data for hydrogen sampled at hydrogen refuelling stations by the 2nd HyCORA measurement campaign. Note that Hy-9 is a repeat sample of Hy-1. [58]

Compounds	ISO 14687-2 threshold [μmol/mol]	PEM water electrolysis with TSA	PEM water electrolysis
		(7 samples) Results [μmol/mol]	(5 samples) Results [μmol/mol]
Water H <sub>2</sub> O	5	< 3	> 100
Methane CH <sub>4</sub>	2	< 0.02	< 0.02 – 0.1
Non CH <sub>4</sub> hydrocarbons	2	0.08 – 0.2	< 0.02 – 0.09
Oxygen O <sub>2</sub>	5	< 0.5 - 2	18- > 500
Helium He	300	< 9 - 45	< 9
Nitrogen N <sub>2</sub>	100	< 1.0 – 4.6	1.2 – 4.5
Argon Ar	100	< 0.5	< 0.5
Carbon dioxide CO <sub>2</sub>	2	< 0.02 – 0.25	0.2 – 5.4
Carbon monoxide CO	0.2	< 0.02	< 0.02
Total sulphur compounds	0.004	< 0.0036	< 0.0036
Formaldehyde HCHO	0.01	< 0.005	< 0.005
Formic acid HCOOH	0.2	< 0.1	< 0.1
Ammonia NH <sub>3</sub>	0.1	< 0.1	< 0.1
Total halogenated	0.05	< 0.005	< 0.005
C2 hydrocarbons	2	< 0.5	< 0.5
C3 hydrocarbons	2	< 1	< 1
C4 hydrocarbons	2	< 1	< 1
C5 hydrocarbons	2	< 1	< 1
C6 - C18 hydrocarbons	2	< 0.05	< 0.05

Figure 56: Impurity data for hydrogen sampled by the EMPIR project [82]



## APPENDIX E: LIST OF ABBREVIATIONS

Abbreviation	Meaning
AEL	Alkaline Water Electrolysis
ATR	Autothermal Reformer
CCUS	Carbon Capture Utilisation and Storage
GHR	Gas Heated Reformer
HHV	Higher Heating Value
HTS	High Temperature Water Gas Shift
LHV	Lower Heating Value
LTS	Low Temperature Water Gas Shift
PEMWE	Proton Exchange Membrane Water Electrolysis
POx	Partial Oxidation
PSA	Pressure Swing Adsorption
S/C ratio	Steam/Carbon Ratio
SMR	Steam Methane Reformer
SOEL	Solid Oxide Electrolysis
TSA	Temperature Swing Adsorption
WGS	Water Gas Shift reaction

**Table 58: List of Abbreviations**

## APPENDIX F: REFERENCES

- [1] Health and Safety Executive, Gas Safety (Management) Regulations 1996. 1996.
- [2] Visser, P.; Gersen, S.; Van essen, M., Regarding specifications for siloxanes in biomethane for domestic equipment. 2013.
- [3] EIGA, IGC Doc 15/06/E Gaseous Hydrogen Stations. 2006.
- [4] EASEE, EASEE-gas - Gas quality specification. 2010.
- [5] EIGA, IGC Doc 121/14 Hydrogen Pipeline Systems. 2014.
- [6] EN 16726, Quality of gas. Group H. 2015.
- [7] SAE J2719, Hydrogen Fuel Quality for Fuel Cell Vehicles. 2015.
- [8] Mark Dorrington, M. L., Iain Summerfield, Paul Robson & Jo Howes, DECC Desk study on the development of a hydrogen-fired appliance supply chain. 2016.
- [9] H21, L. C. G., H21 Final Report. 2016.
- [10] BCGA BCGA Code of Practice 41 - The design, construction, maintenance and operation of filling stations dispensing gaseous fuels; 2016.
- [11] EN 16723-1, Natural gas and biomethane for use in transport and biomethane for injection in the natural gas network - Specifications for biomethane for injection in the natural gas network. 2016.
- [12] EN 16723-2, Natural gas and biomethane for use in transport and biomethane for injection in the natural gas network - Automotive fuels specification. 2017.
- [13] EN 17124, Hydrogen fuel - Product specification and quality assurance - Proton exchange membrane (PEM) fuel cell applications for road vehicles. 2018.
- [14] ISO/FDIS 14687, Hydrogen fuel - Product specification. 2018.
- [15] Evans, M. P. T. Next steps for the gas grid; 2017.
- [16] ISO 14687-1, Hydrogen fuel - Product Specification - Part 1: All applications except proton exchange membrane (PEM) fuel cell for road vehicles. 1999.
- [17] ISO 14687-2, Hydrogen fuel - Product Specification - Part 2: Proton exchange membranes (PEM) fuel cell applications for road vehicles. 2012.
- [18] ISO 14687-3, Hydrogen fuel - Product Specification - Part 3: Proton exchange membranes (PEM) fuel cell applications for stationary applications. 2014.
- [19] European Commission, Directive 2014/94/EU of the European Parliament and of the Council on the deployment of alternative fuels infrastructure Brussels, 2014.
- [20] Dodds, P. E.; Staffell, I.; Hawkes, A. D.; Li, F.; Grünewald, P.; McDowall, W.; Ekins, P., Hydrogen and fuel cell technologies for heating: A review. *International Journal of Hydrogen Energy* 2015, 40 (5), 2065-2083.
- [21] D. Sadler and H. S. Anderson, "H21 North of England," 2018.
- [22] U. Heucke, "Greener hydrogen for refineries . CO2 capture and utilisation from hydrogen plants. Linde presentation," 2018, no. November.
- [23] T. Bacquart *et al.*, "Probability of occurrence of ISO 14687-2 contaminants in hydrogen: Principles and examples from steam methane reforming and electrolysis (water and chlor-alkali) production processes model," *Int. J. Hydrogen Energy*, vol. 43, no. 26, pp. 11872-11883, 2018.
- [24] IEAGHG, "Techno - Economic Evaluation of SMR Based Standalone (Merchant) Hydrogen Plant with CCS," *Tech. Rev. 2017-02*, no. February, p. 286, 2017.
- [25] J. A. Ritter and A. D. Ebner, "State-of-the-art adsorption and membrane separation processes for hydrogen production in the chemical and petrochemical industries," *Sep. Sci. Technol.*, vol. 42, no. 6, pp. 1123-1193, 2007.
- [26] M. Cairns-Terry, Progressive Energy, and Advanced Plasma Power, "Biohydrogen: Production of hydrogen by gasification of waste," no. July, 2017.
- [27] Air Products and Chemicals, "PRISM ® Membrane Systems For Oil Refinery Applications Brochure." [Online]. Available: <http://www.airproducts.com/~media/Files/PDF/products/supply-options/prism-membrane/en-prism-process-gas-brochure.pdf?la=en>. [Accessed: 17-Dec-2018].
- [28] H. Purification, "UOP Polysep™ Membrane Systems for Hydrogen Recovery and Purification." [Online]. Available: <https://www.uop.com/?document=polysep-membrane-for-gas-extraction-purification&download=1>. [Accessed: 17-Dec-2018].
- [29] Air Liquide, "Hydrogen Membrane Overview," 2016. [Online]. Available: [https://www.airliquideadvancedseparations.com/sites/medal/files/2016/11/28/alias\\_h2\\_brochure.pdf](https://www.airliquideadvancedseparations.com/sites/medal/files/2016/11/28/alias_h2_brochure.pdf). [Accessed: 21-Dec-2018].
- [30] Linde, "Purge gas recovery." [Online]. Available: [https://www.linde-engineering.com/en/images/Brochure - Purge gas recovery\\_tcm19-486079.pdf](https://www.linde-engineering.com/en/images/Brochure - Purge gas recovery_tcm19-486079.pdf). [Accessed: 03-Jan-2019].
- [31] M. Voldsund, K. Jordal, and R. Anantharaman, "Hydrogen production with CO2 capture," *Int. J.*

- Hydrogen Energy*, vol. 41, no. 9, pp. 4969–4992, 2016.
- [32] S. Kluiters, "Status review on membrane systems for hydrogen separation," 2004.
- [33] J. Howes and E4tech and Element Energy, "Hydrogen and Fuel Cells: Opportunities for Growth: Mini roadmaps (appendix to roadmap report)," *E4Tech*, no. November, 2016.
- [34] W. G. Colella, B. D. James, and J. M. Moton, "Techno-economic Analysis of PEM Electrolysis for Hydrogen Production," *Electrolytic Hydrogen Production Workshop*, 2014. [Online]. Available: [https://www.energy.gov/sites/prod/files/2014/08/f18/fcto\\_2014\\_electrolytic\\_h2\\_wkshp\\_colella1.pdf](https://www.energy.gov/sites/prod/files/2014/08/f18/fcto_2014_electrolytic_h2_wkshp_colella1.pdf). [Accessed: 08-Jan-2019].
- [35] Giacomini, "H<sub>2</sub>ydroGEM CCF01-2018," 2018. [Online]. Available: [https://static.giacomini.com/giacomini.com/catalog/technical\\_documentation/CCF01.pdf](https://static.giacomini.com/giacomini.com/catalog/technical_documentation/CCF01.pdf). [Accessed: 08-Jan-2019].
- [36] HSE, "EH40/2005 Workplace exposure limits," vol. 3rd Editio, 2018.
- [37] ISO, "ISO DIS 14687," 2019.
- [38] HSE, "Iron Mains Replacement Programme." [Online]. Available: <http://www.hse.gov.uk/gas/supply/mainsreplacement/index.htm>. [Accessed: 10-Jan-2019].
- [39] U.S. Department of Energy, J. M. Ohi, N. Vanderborgh, and G. Voecks, "Hydrogen Fuel Quality Specifications for Polymer Electrolyte Fuel Cells in Road Vehicles," 2016.
- [40] I. A. Zlochower and G. M. Green, "The limiting oxygen concentration and flammability limits of gases and gas mixtures," *J. Loss Prev. Process Ind.*, vol. 22, no. 4, pp. 499–505, 2009.
- [41] IEAGHG and G. Collidi, "IEAGHG Technical Review March 2017 Reference data and Supporting Literature Reviews for SMR Based Hydrogen Production with," 2017.
- [42] A. Buttler and H. Spliethoff, "Current status of water electrolysis for energy storage, grid balancing and sector coupling via power-to-gas and power-to-liquids: A review," *Renew. Sustain. Energy Rev.*, vol. 82, no. September 2017, pp. 2440–2454, 2018.
- [43] G. Hoffheinze, N. Nelly, and A. Ete, "Evaluation of hydrogen demonstration systems and united kingdom hydrogen infrastructure," 2007.
- [44] Guy Maisonnier, J. Perrin, R. Steinberger-wilckens, and S. C. Trümper, "' European Hydrogen Infrastructure Atlas ' and ' Industrial Excess Hydrogen Analysis ' PART II : Industrial surplus hydrogen and markets and production," *Roads2HyCom*, no. DELIVERABLE 2.1 AND 2.1a, p. 86, 2007.
- [45] B. M. Besancon, V. Hasanov, R. Imbault-Lastapis, R. Benesch, M. Barrio, and M. J. MølInvik, "Hydrogen quality from decarbonized fossil fuels to fuel cells," *Int. J. Hydrogen Energy*, vol. 34, no. 5, pp. 2350–2360, 2009.
- [46] IEA, "Technology Roadmap for Hydrogen and Fuel cells," p. 81, 2015.
- [47] Linde, K. Wawrzinek, and C. Keller, "Industrial Hydrogen Production & Technology," *Production*, 2007. [Online]. Available: [https://www.hzg.de/imperia/md/content/gkss/institut\\_fuer\\_werkstoffforschung/wtn/h2-speicher/funchy/funchy-2007/5\\_linde\\_wawrzinek\\_funchy-2007.pdf](https://www.hzg.de/imperia/md/content/gkss/institut_fuer_werkstoffforschung/wtn/h2-speicher/funchy/funchy-2007/5_linde_wawrzinek_funchy-2007.pdf). [Accessed: 18-Dec-2018].
- [48] S. Sircar and T. C. Golden, "Pressure Swing Adsorption Technology for Hydrogen Production," in *Hydrogen and syngas production and purification*, 2010, pp. 414–450.
- [49] D. Mendez, A. Mendes, L. Madeira, A. Iulianelli, J. Sousa, and A. Basile, "The water-gas shift reaction: from conventional catalytic systems to Pd-based membrane reactors – a review," *ASIA-PACIFIC J. Chem. Eng.*, vol. 21, no. 5, pp. 111–137, 2010.
- [50] J. R. Ladebeck, J. P. Wagner, W. Vielstich, A. Lamm, and H. A. Gasteiger, "Catalyst development for water-gas shift Chapter 16 Catalyst development for water-gas shift," *Technol. Appl.*, vol. 3, no. 2, pp. 190–201, 2003.
- [51] Argonne National Laboratory *et al.*, "Catalytic Autothermal Reforming Of Hydrocarbon Fuels For Fuel Cell," *Am. Inst. Chem. Eng. Spring Natl. Meet. 2002*, 2002.
- [52] Johnson Matthey, "Reforming Technologies," 2018. [Online]. Available: <https://matthey.com/products-and-services/chemical-processes/core-technologies/reforming>. [Accessed: 18-Dec-2018].
- [53] H. Olsson, P. Rudbeck, K. H. Andersen, B. H. Olsson, P. Rudbeck, and K. H. Andersen, "Haldor Topsoe: Adding Hydrogen Production Capacity by Heat Exchange Reforming," 2007. [Online]. Available: [https://www.topsoe.com/sites/default/files/topsoe\\_hter\\_adding\\_prod\\_cap.ashx\\_.pdf](https://www.topsoe.com/sites/default/files/topsoe_hter_adding_prod_cap.ashx_.pdf). [Accessed: 12-Nov-2018].
- [54] G. Di Marcoberardino, D. Vitali, F. Spinelli, and M. Binotti, "Green Hydrogen Production from Raw Biogas: A Techno-Economic Investigation of Conventional Processes Using Pressure Swing Adsorption Unit," *Processes*, vol. 6, no. 3, p. 19, 2018.
- [55] H21, "Discussion with Stakeholder," 2019.
- [56] Linde, "Hydrogen Recovery by Pressure Swing Adsorption," *Engineering*, pp. 4–8, 2010.
- [57] T. A. Aarhaug, "HyCoRA – Deliverable 3.2 Measurement of hydrogen quality variation at various

- HRS with different fuel feedstock," 2015.
- [58] T. A. Aarhaug and O. Kjos, "HyCoRA – D3 . 3 Results from the 2 nd HRS measurement campaign," 2017.
- [59] Shell, "Adip ® -x." [Online]. Available: [https://www.shell.com/business-customers/global-solutions/gas-processing-licensing/licensed-technologies/acid-gas-removal/adip-process/\\_jcr\\_content/par/textimage.stream/1487623032063/e1036bff9415d92b3c102ab4c57dee386e45468064fca3a58585d8d894ecab48/adip-x](https://www.shell.com/business-customers/global-solutions/gas-processing-licensing/licensed-technologies/acid-gas-removal/adip-process/_jcr_content/par/textimage.stream/1487623032063/e1036bff9415d92b3c102ab4c57dee386e45468064fca3a58585d8d894ecab48/adip-x). [Accessed: 12-Dec-2018].
- [60] B. Zhao *et al.*, "Enhancing the energetic efficiency of MDEA/PZ-based CO<sub>2</sub> capture technology for a 650 MW power plant: Process improvement," *Appl. Energy*, vol. 185, pp. 362–375, 2017.
- [61] F. Gallucci, E. Fernandez, P. Corengia, and M. van Sint Annaland, "Recent advances on membranes and membrane reactors for hydrogen production," *Chem. Eng. Sci.*, vol. 92, pp. 40–66, 2013.
- [62] SAES, "SAES Hydrogen Purifiers." [Online]. Available: <http://www.saespuregas.com/Products/Gas-Purifier/Hydrogen/Palladium-Membrane/Home.html>. [Accessed: 14-Dec-2018].
- [63] H. Yakabe, H. Kurokawa, Y. Shirasaki, and I. Yasuda, *Operation of a palladium membrane reformer system for hydrogen production: The case of Tokyo Gas*. Woodhead Publishing Limited, 2014.
- [64] G. Di Marcoberardino *et al.*, "Achievements of European projects on membrane reactor for hydrogen production," *J. Clean. Prod.*, vol. 161, pp. 1442–1450, 2017.
- [65] E. Fernandez *et al.*, "Palladium based membranes and membrane reactors for hydrogen production and purification: An overview of research activities at Tecnalia and TU/e," *Int. J. Hydrogen Energy*, vol. 42, no. 19, pp. 13763–13776, 2017.
- [66] T. A. Peters, R. Bredesen, and H. J. Venvik, "Hydrogen Production : Long-term Stability and," vol. 2, pp. 177–211.
- [67] "FERRET Project." [Online]. Available: <http://www.ferret-h2.eu/>. [Accessed: 17-Dec-2018].
- [68] Tecnalia, "FERRET WP3- Public report on production costs and scale up of the membrane production," 2017.
- [69] GRASYS, "Membrane Technology." [Online]. Available: <http://www.grasys.com/technologies/membrane/>. [Accessed: 09-Jan-2019].
- [70] Honeywell UOP, "UOP Polysep Membranes." [Online]. Available: <https://www.uop.com/equipment/hydrogen-separation/membrane-systems/>. [Accessed: 17-Dec-2018].
- [71] Generon, "Syngas H<sub>2</sub> : CO Ratio Adjustment GENERON ® Membrane Technology," 2016.
- [72] N. Patel, K. Ludwig, P. Morris, and Air Products and Chemicals, "Insert flexibility into your hydrogen network — Part 1," *Hydrocarb. Process.*, no. September 2005, pp. 75–83, 2005.
- [73] Air Liquide, "Cryocap." [Online]. Available: <https://www.engineering-airliquide.com/cryocap-h2-cryogenic-CO2-separation>. [Accessed: 19-Dec-2018].
- [74] P. Terrien, F. Lockwood, L. Granados, and T. Morel, "CO<sub>2</sub> capture from H<sub>2</sub> plants: Implementation for EOR," *Energy Procedia*, vol. 63, pp. 7861–7866, 2014.
- [75] MEMPHYS, "A brief presentation about MEMPHYS," no. 735533, 2018.
- [76] "HyGrid." [Online]. Available: <https://www.higrd-h2.eu/content/home>. [Accessed: 19-Dec-2018].
- [77] Z. Li, W. Mi, J. Gong, Z. Lu, L. Xu, and Q. Su, "CO removal by two-stage methanation for polymer electrolyte fuel cell," *J. Nat. Gas Chem.*, vol. 17, no. 4, pp. 359–364, 2008.
- [78] K. Ledjeff-Hey, J. Roes, and R. Wolters, "CO<sub>2</sub>-scrubbing and methanation as purification system for PEFC," *J. Power Sources*, vol. 86, pp. 556–561, 2000.
- [79] Johnson Matthey, "Johnson Matthey Methanation Catalysts." [Online]. Available: <https://matthey.com/products-and-services/chemical-processes/chemical-catalysts/methanation-catalysts>. [Accessed: 03-Jan-2019].
- [80] Haldor Topsoe, "Haldor Topsoe Methanation Catalysts." [Online]. Available: <https://www.topsoe.com/processes/hydrogen/methanation>. [Accessed: 03-Jan-2019].
- [81] Element Energy and Jacobs, "Hydrogen supply chain evidence base," 2018.
- [82] T. Bacquart *et al.*, "International Workshop: Metrology for sustainable hydrogen energy applications Impurities found in real hydrogen production samples," 2018. [Online]. Available: <http://projects.lne.eu/jrp-hydrogen/download/2069/>. [Accessed: 12-Dec-2018].
- [83] FCH-JU, "REselyser Project Report," 2015.
- [84] NEL hydrogen, "Nel Hydrogen Electrolyser Brochure," 2016. [Online]. Available: [http://nelhydrogen.com/assets/uploads/2017/01/Nel\\_Electrolyser\\_brochure.pdf](http://nelhydrogen.com/assets/uploads/2017/01/Nel_Electrolyser_brochure.pdf). [Accessed: 04-Jan-2019].
- [85] E4tech and Element Energy, "Development of Water Electrolysis in the European Union," no. February, 2014.

- [86] D. Peterson and E. Miller, "DOE Hydrogen and Fuel Cells Program Record - Hydrogen Production Cost from Solid Oxide Electrolysis," 2016.
- [87] D. Bessarabov and P. Millet, *PEM Water Electrolysis Volume 2*. Elsevier, 2018.
- [88] Wuppertal Institute and Covestro, "CO2 ReUse NRW- Evaluating gas sources, demand and utilization for CO2 and H2 within the North Rhine- Westphalia area," 2015.
- [89] H2Tools, "Merchant Hydrogen Capacities Europe." [Online]. Available: <https://h2tools.org/hyarc/hydrogen-production>. [Accessed: 20-Dec-2018].
- [90] BOC, "FactSheet: Bulk Hydrogen Trailers – H2," 2012. [Online]. Available: [https://www.boconline.co.uk/en/images/Bulk-Hydrogen-Trailers-factsheet\\_tcm410-54559.pdf](https://www.boconline.co.uk/en/images/Bulk-Hydrogen-Trailers-factsheet_tcm410-54559.pdf). [Accessed: 12-Dec-2018].
- [91] E. and I. S. Department for Business, "Energy Consumption in the UK 2018 Update," 2018. [Online]. Available: <https://www.gov.uk/government/collections/energy-consumption-in-the-uk>. [Accessed: 11-Dec-2018].
- [92] ISO, "ISO/DIS 14687-2: Hydrogen fuel- Product Specification - Proton exchange membrane ( PEM ) fuel cell applications for road vehicles," 2011.
- [93] Leeds City Gate, "H21 Report," 2016.
- [94] Kiwa and E4Tech, "DECC Desk study on the development of a hydrogen-fired appliance supply chain," no. July, 2016.
- [95] Ofgem, "Reional differences in network charges," *Ofgem E-Serve*, no July, 2015
- [96] ISO, "ISO DIS 14687," 2019.
- [97] BEIS, "Energy Consumption in the UK (ECUK) 2018 Data Tables," 2018. [Online]. Available: <https://www.gov.uk/government/statistics/energy-consumption-in-the-uk>. [Accessed: 04-Mar-2019].
- [98] HSE, "EH40/2005 Workplace exposure limits," vol. 3rd Editio, 2018.
- [99] U.S. Department of Energy, J. M. Ohi, N. Vanderborgh, and G. Voecks, "Hydrogen Fuel Quality Specifications for Polymer Electrolyte Fuel Cells in Road Vehicles," 2016.
- [100] D. Sadler and H. S. Anderson, "H21 North of England," 2018.
- [101] E. & I. S. Department for Business and BEIS, "BEIS 2018 Fossil Fuel Price Assumptions," no. November, p. 12, 2018.
- [102] BEIS, "BEIS Energy and Emissions projects." [Online]. Available: <https://www.gov.uk/government/collections/energy-and-emissions-projections>. [Accessed: 27-Feb-2019].
- [103] IEAGHG, "Techno - Economic Evaluation of SMR Based Standalone (Merchant) Hydrogen Plant with CCS," *Tech. Rev. 2017-02*, no. February, p. 286, 2017.
- [104] HM Treasury, *The Green Book - Central Government Guidance on Appraisal and Evaluation 2018*. 2011.
- [105] U. Heucke, "Greener hydrogen for refineries . CO2 capture and utilisation from hydrogen plants. Linde presentation," 2018, no. November.
- [106] M. Voldsund, K. Jordal, and R. Anantharaman, "Hydrogen production with CO2 capture," *Int. J. Hydrogen Energy*, vol. 41, no. 9, pp. 4969–4992, 2016.
- [107] J. A. Ritter and A. D. Ebner, "State-of-the-art adsorption and membrane separation processes for hydrogen production in the chemical and petrochemical industries," *Sep. Sci. Technol.*, vol. 42, no. 6, pp. 1123–1193, 2007.
- [108] IEAGHG and G. Collidi, "IEAGHG Technical Review March 2017 Reference data and Supporting Literature Reviews for SMR Based Hydrogen Production with," 2017.
- [109] H21, "Discussion with Stakeholder," 2019.
- [110] S. Sircar and T. C. Golden, "Pressure Swing Adsorption Technology for Hydrogen Production," in *Hydrogen and syngas production and purification*, 2010, pp. 414–450.
- [111] D. D. Papadias, S. Ahmed, R. Kumar, and F. Joseck, "Hydrogen quality for fuel cell vehicles - A modeling study of the sensitivity of impurity content in hydrogen to the process variables in the SMR-PSA pathway," *Int. J. Hydrogen Energy*, vol. 34, no. 15, pp. 6021–6035, 2009.
- [112] BOC, "FactSheet: Bulk Hydrogen Trailers – H2," 2012. [Online]. Available: [https://www.boconline.co.uk/en/images/Bulk-Hydrogen-Trailers-factsheet\\_tcm410-54559.pdf](https://www.boconline.co.uk/en/images/Bulk-Hydrogen-Trailers-factsheet_tcm410-54559.pdf). [Accessed: 12-Dec-2018].
- [113] J. Tjønnås, F. Zenith, I. J. Halvorsen, M. Klages, and J. Scholta, "Control of Reversible Degradation Mechanisms in Fuel Cells: Mitigation of CO contamination," *IFAC-PapersOnLine*, vol. 49, no. 7, pp. 302–307, 2016.
- [114] US Department of Energy, "DOE Technical Targets for Fuel Cell Systems." [Online]. Available: <https://www.energy.gov/eere/fuelcells/doe-technical-targets-fuel-cell-systems-stationary-combined-heat-and-power>.
- [115] HyGrid, "WP2 – Industrial Requirements Definition HyGrid pre-commercial scale plant report,"

- 
- 2016.
- [116] BEIS, "Sub-national electricity and gas consumption statistics - Regional and Local Authority," no. January, 2018.
  - [117] V.Schroeder and K. Holtappels Explosion characteristics of hydrogen-air and hydrogen-oxygen mixtures at elevated pressures. Paper presented at International Conference on Hydrogen Safety 2005. (<http://conference.ing.unipi.it/ichs2005/ICHS-Papers/>)
  - [118] See for example data presented from the HySafe project <http://www.hysafe.org/>
  - [119] N. Nanninga, A. Slifka, Y. Levy and C. White. "Review of Fatigue Crack Growth for Pipeline Steels Exposed to Hydrogen" J. Res. Natl. Inst. Stand. Technol. 115, 437-452 (2010)]
  - [120] EH40/2005 Workplace exposure limits (Third edition, published 2018)
  - [121] Z. Li, W. Mi, J. Gong, Z. Lu, L. Xu, and Q. Su, "CO removal by two-stage methanation for polymer electrolyte fuel cell," J. Nat. Gas Chem., vol. 17, no. 4, pp. 359–364, 2008.
  - [122] <https://matthey.com/products-and-services/chemical-processes/chemical-catalysts/methanation-catalysts>

## APPENDIX G: LIST OF TABLES

- Table 1: Draft recommendation for a UK hydrogen quality standard for heat applications based on existing standards and documents
- Table 2: Summary of relevant documentary standards or technical reports that provide guidance on natural gas or hydrogen quality
- Table 3: Range of impurity levels for hydrogen produced by a reformer with carbon capture.
- Table 4: Suitability of methanation and PSA for various target levels of CO
- Table 5: Range of impurity levels for hydrogen produced by a reformer with carbon capture.
- Table 6: Range of impurity levels expected after a methanation reaction
- Table 7: Impurities found in hydrogen produced by PEMWE.
- Table 8: Impact of Impurities on End Users – Carbon Monoxide
- Table 9: Impact of Impurities on End Users – Water
- Table 10: Impact of Impurities on End Users – Carbon Dioxide
- Table 11: Impact of Impurities on End Users – Methane
- Table 12: Impact of Impurities on End Users – Inert gases
- Table 13: Impact of Impurities on End Users – Oxygen
- Table 14: Impact of Impurities on End Users – Sulphur Compounds
- Table 15: Literature values for SMR syngas compositions
- Table 16: Literature values for ATR syngas compositions
- Table 17: Modelled data of 1.5 GW production plants. [21]
- Table 18: Syngas produced in the Biohydrogen project [26]
- Table 19: Literature values for syngas compositions after the water gas shift reaction.
- Table 20: Literature data on CO<sub>2</sub> capture from syngas using amine based methods
- Table 21: Odorant Suitability for Fuel Cells
- Table 22: Flammability Limits
- Table 23: Levels of purity considered for the cost benefit analysis, their reason for inclusion and the potential impact on different end uses: Red is unsafe, orange is safe but not usable for solid oxide fuel cells, green is safe but does not meet the ISO/DIS 14687 standard for fuel cell vehicles, blue meets this standard.
- Table 24: Hydrogen production information from the H21 NoE report (Source: [100])
- Table 25: Hydrogen production information for each of the reformers considered
- Table 26: Operating cost assumptions
- Table 27: Levelised cost of hydrogen (LCOH) with no purification steps
- Table 28: Literature values for syngas compositions after the water gas shift reaction
- Table 29: Calculated CO<sub>2</sub> levels after carbon capture at high pressure using an amine wash
- Table 30: Summary of modelled PSA data in the study by Besancon et. al. [45]
- Table 31: Heat generated by burning the tail gas produced at each targeted purity level and for assumed hydrogen losses at 250 ppm of between 7 and 15 %
- Table 32: Sensitivity of PSA impact on LCOH to assumed PSA capex
- Table 33: LCOE and LCOH comparison with and without methanation
- Table 34: Cost of methanation: Sensitivity to assumed methanation capex
- Table 35: Cost of methanation: Sensitivity to assumed water removal costs
- Table 36: Cost of methanation: Sensitivity to assumed syngas
- Table 37: Calculated LCOE associated with varying levels of purity.
- Table 38: Green denotes no impact of that impurity level on the fuel cell, yellow denotes some impact on performance, and red denotes an impact that is likely to be unacceptable, meaning that clean-up would be required.
- Table 39: Targeted parameters for the MEMPHYS project [75]
- Table 40: Cost associated with transporting additional inert gases in the gas network
- Table 41: Costs associated with sampling and verification of hydrogen at the point of production (POP) and hydrogen refuelling station (HRS)

- Table 42: Summary of costs downstream of production associated with each level of purity considered. Emboldened costs are those noted to be the most significant costs.
- Table 43: Table will be used to calculate the ratio of combustion : FC demand, below which it is cheaper to purify to ISO/DIS 14687 standard at the reformer
- Table 44: Comparison of heat and transport hydrogen demand scenarios
- Table 45: Cost savings for producing hydrogen to purity level compared to the ISO/DIS 14687 vehicle PEMFC standard, compared to the additional downstream costs for PEMFCs. If each purity level were selected to be the safe level of hydrogen, the ratio of PEMFC hydrogen demand compared to combustion hydrogen demand above which purifying to the fuel cell standard would be cheaper overall is calculated.
- Table 46: Cost savings for producing hydrogen to purity level compared to the ISO/DIS 14687 vehicle PEMFC standard, compared to the additional downstream costs for PEMFCs. If each purity level were selected to be the safe level of hydrogen, the ratio of PEMFC hydrogen demand compared to combustion hydrogen demand above which purifying to the fuel cell standard would be cheaper overall is calculated.
- Table 47: Gas quality specifications according to GS(M)R 1996
- Table 48: Gas specification for natural gas quality proposed in EASEE-gas
- Table 49: Hydrogen quality specification from SAE J2719 (all levels specified in  $\mu\text{mol mol}^{-1}$  unless stated otherwise)
- Table 50: Hydrogen purity specifications proposed in Leeds City Gate H21 final report
- Table 51: Fuel quality specifications for PEM fuel cell road vehicle applications in EN 17124
- Table 52: Classification grades of hydrogen in ISO/FDIS 14687
- Table 53: Fuel quality specification for PEM fuel cell road vehicle application in ISO/FDIS 14687
- Table 54: Fuel quality specifications for PEM fuel cell stationary applications in ISO/FDIS 14687
- Table 55: Fuel quality specification for applications other than PEM fuel cell road vehicle and stationary applications in ISO/FDIS 14687
- Table 56: Hydrogen purity provided by different production processes
- Table 57: List of UK Production Sites
- Table 58: List of Abbreviations



## APPENDIX H: LIST OF FIGURES

- Figure 1: Natural gas and hydrogen flows for an ATR using hydrogen as a fired heater fuel.
- Figure 2: Natural gas and hydrogen flows for an ATR using natural gas as a fired heater fuel.
- Figure 3: Natural gas and hydrogen flows for an SMR.
- Figure 4: LCOE calculated for purification using a PSA. A capex of 10 % of the total reformer capex and a hydrogen loss of 9% are assumed for a PSA purifying to 250ppm CO.
- Figure 5: Additional LCOE compared to purifying to 250 ppm CO using a PSA. A capex of 10 % of the total reformer capex and a hydrogen loss of 9% are assumed for a PSA purifying to 250ppm CO.
- Figure 6: Calculated annual additional costs, compared to reducing CO to 250ppm, for a typical household when a PSA is used to increase purity levels for and an ATR using hydrogen as a fuel for the fired heater produces hydrogen with CO<sub>2</sub> emissions <9 g/kWh
- Figure 7: Comparison of the costs of using methanation to reach less than 50 ppm CO and a PSA to reach 250 ppm and 50 ppm CO for an SMR.
- Figure 8: Additional costs to a typical household associated with increasing levels of hydrogen purity, when CO<sub>2</sub> emissions of <20 g/kWh are required
- Figure 9: An outline of the costs associated with varying levels of purity of hydrogen downstream of production
- Figure 10: For carbon emissions of <9 g/kWh. Ratio of PEMFC hydrogen demand to combustion hydrogen demand above which it makes sense to purify to the ISO vehicle PEMFC standard instead of the purity plotted. Scenario values for this ratio are marked with dashed lines. If the dashed line of a scenario lies above the plotted point, then it is more cost effective to purify to the PEMFC standard than the purity of that plotted point.
- Figure 11: For CO<sub>2</sub> emissions <20 g/kWh, threshold ratios of PEMFC hydrogen demand to combustion hydrogen demand above which it makes sense to purify to the ISO vehicle PEMFC standard instead of the purity plotted. Scenario values for this ratio are marked with dashed lines. If the dashed line of a scenario lies above the plotted point, then it is more cost effective to purify to the PEMFC standard than the purity of that plotted point.
- 
- Figure 1: Factors influencing hydrogen purity and the development of a recommended specification
- Figure 2: Hydrogen production routes to consider in the cost-benefit analysis. Electrolysis may be alkaline electrolysis or proton exchange membrane electrolysis.
- Figure 3: An overview of the steps for hydrogen production from syngas
- Figure 4: Diagram of an SMR [47]
- Figure 5: A diagram of an ATR reaction chamber [47]
- Figure 6: A depiction of the adsorption and desorption steps for a PSA bed, the bed is filled with adsorbent granules, pure hydrogen product flows out of the top of the bed, and the impure off-gas out of the bottom.
- Figure 7: Relative strengths of adsorption to a Linde PSA material [56]
- Figure 8: Modelled variation of impurity concentration with hydrogen yield for an SMR [45]
- Figure 9: Modelled variation of impurity concentration with hydrogen yield for an ATR [45]
- Figure 10: Modelled variations in impurity concentrations with H<sub>2</sub> recovery for 1500kg/day SMR [39]
- Figure 11: Cost components of hydrogen refuelling station as function of CO concentration [39]
- Figure 12: Membrane purification of hydrogen from syngas [61]
- Figure 13: GRASYS gas penetration rate through polymer membranes (Source: [49])
- Figure 14: Air Liquide gas penetration rate through polymer membranes [29]
- Figure 15: Electrochemical purification [75]
- Figure 16: UK Hydrogen production by source
- Figure 17: UK hydrogen production by location

- Figure 18: Schematic concept for hydrogen purity at point of use
- Figure 19: Impact on Wobbe Number through CO<sub>2</sub> Dilution
- Figure 20: Distributed purification stage with output feeding multiple end users (requires a tail-gas vent).
- Figure 21: Suggested approach for specific purity-sensitive application
- Figure 22: Purification routes for consideration in the cost benefit analysis
- Figure 23: Framework proposed in Tasks 1b and 1c for the Cost Benefit Analysis
- Figure 24: Relative strengths of adsorption to a different PSA adsorbents [45]
- Figure 25: Natural gas and hydrogen flows for an ATR using hydrogen as a fired heater fuel.
- Figure 26: Natural gas and hydrogen flows for an ATR using natural gas as a fired heater fuel.
- Figure 27: Natural gas and hydrogen flows for an SMR.
- Figure 28: Breakdown of the contributions of the reformer capital cost and operating costs to the LCOE of hydrogen produced by an ATR, using hydrogen as the fired heater fuel and with no purification.
- Figure 29: Example gas flows for an ATR using hydrogen as a fuel for the fired heater and a PSA for purification, when the energy content of the tail gas is less than the fired heater demand.<sup>13</sup>
- Figure 30: Example gas flows for an ATR using natural gas as a fuel for the fired heater and a PSA for purification, when the energy content of the tail gas is greater than the fired heater demand.
- Figure 31: Impact of a PSA on an ATR using natural gas as a fuel for the fired heater
- Figure 32: Impact of a PSA on an SMR
- Figure 33: Additional LCOE for increasing levels of purity beyond 250 ppm CO with a PSA, with an assumed hydrogen loss of 9% and a PSA capex of 10% of the reformer capex, at 250 ppm CO
- Figure 34: Impact of varying the assumed PSA hydrogen loss at 250 ppm on the additional LCOE associated with purifying beyond 250 ppm CO
- Figure 35: Sensitivity of PSA impact on LCOE to assumed PSA capex for an ATR using hydrogen as a fuel for the fired heater (CO<sub>2</sub> emissions: 8 g/kWh)
- Figure 36: Sensitivity of PSA impact on LCOE to assumed PSA capex for an ATR using methane as a fuel for the fired heater (CO<sub>2</sub> emissions: 30 g/kWh)
- Figure 37: Sensitivity of PSA impact on LCOE to assumed PSA capex for an SMR (CO<sub>2</sub> emissions: 20 g/kWh)
- Figure 38: Comparison of the sensitivity of the additional LCOE to the assumed PSA hydrogen loss, varied between 5 and 13%, and PSA capex, varied between 8 and 15%, at 250 ppm. The impact on a PSA purifying SMR produced hydrogen to <0.2 ppm CO and 300 ppm N<sub>2</sub> is examined.
- Figure 39: Additional LCOE for increasing levels of purity with a PSA and assumed hydrogen recovery of 9% and PSA capex of 10% of the reformer cost. Argon is not expected to be present for hydrogen produced by an SMR and so no point is included for purifying Ar to 300 ppm for an SMR.
- Figure 40: Flows of gas demonstrating the impact of methanation and water removal on an ATR burning hydrogen
- Figure 41: Flows of gas demonstrating the impact of methanation and water removal on an ATR burning natural gas
- Figure 42: Comparison of the impacts of the range of assumed methanation capital costs, outlined in Table 34, and water removal costs, outlined in Table 41 on the LCOE with methanation.
- Figure 43: Figure 53: LCOE calculated for different production routes and purity levels using a PSA for purification.
- Figure 44: Calculated annual additional costs, compared to reducing CO to 250ppm, for a typical household when a PSA is used to increase purity levels for an ATR using hydrogen as a fuel for the fired heater.

- Figure 45: Comparison of costs associated with using a PSA and methanation for purification with an ATR using hydrogen as a fired heater fuel. Error bars display the range of LCOEs associated with the range of plausible PSA capital costs and water removal costs for methanation
- Figure 46: Range of potential annual additional costs to a typical household, associated with using a PSA to increase the purity beyond 250 ppm CO, with carbon dioxide emissions of less than 20 g/kWh
- Figure 47: Comparison of the costs of using methanation to reach less than 50 ppm CO and a PSA to reach 250 ppm and 50 ppm CO for an SMR.
- Figure 48: Additional costs to a typical household associated with increasing levels of hydrogen purity, when methanation is included as a viable option for purifying hydrogen.
- Figure 49: An outline of the costs associated with varying levels of purity of hydrogen downstream of production
- Figure 50: For carbon emissions of  $<9$  g/kWh. Ratio of PEMFC hydrogen demand to combustion hydrogen demand above which it makes sense to purify to the ISO vehicle PEMFC standard instead of the purity plotted. Scenario values for this ratio are marked with dashed lines. If the dashed line of a scenario lies above the plotted point, then it is more cost effective to purify to the PEMFC standard than the purity of that plotted point.
- Figure 51: For CO<sub>2</sub> emissions  $<20$  g/kWh, threshold ratios of PEMFC hydrogen demand to combustion hydrogen demand above which it makes sense to purify to the ISO vehicle PEMFC standard instead of the purity plotted. Scenario values for this ratio are marked with dashed lines. If the dashed line of a scenario lies above the plotted point, then it is more cost effective to purify to the PEMFC standard than the purity of that plotted point.
- Figure 52: Process flow diagram for the Port Jerome Plant
- Figure 53: Impurity data for hydrogen sampled at hydrogen refuelling stations by the 1st HyCORA measurement campaign. [57]
- Figure 54: Impurity data for hydrogen sampled at hydrogen refuelling stations by the 2nd HyCORA measurement campaign. Note that Hy-12 is a repeat sample of Hy-8. [58]
- Figure 55: Impurity data for hydrogen sampled at hydrogen refuelling stations by the 2nd HyCORA measurement campaign. Note that Hy-9 is a repeat sample of Hy-1. [58]
- Figure 56: Impurity data for hydrogen sampled by the EMPIR project [82]



## About DNV GL

DNV GL is a global quality assurance and risk management company. Driven by our purpose of safeguarding life, property and the environment, we enable our customers to advance the safety and sustainability of their business. We provide classification, technical assurance, software and independent expert advisory services to the maritime, oil & gas, power and renewables industries. We also provide certification, supply chain and data management services to customers across a wide range of industries. Operating in more than 100 countries, our experts are dedicated to helping customers make the world safer, smarter and greener.



[www.Hy4Heat.info](http://www.Hy4Heat.info)  
[@hy4heat](https://twitter.com/hy4heat)